

#8800 Series:

Gauge .050

- #8806 (6') ▲
- #8807 (7') ▲
- #8808 (8') ▲
- #8810 (10') ▲
- #8812 (12') ▲

#8800 Series:

Gauge .125

- #8836 (6') ▲
- #8837 (7') ▲
- #8838 (8') ▲
- #8840 (10') ▲
- #8842 (12') ▲
- #8844 (14') ▲
- #8846 (16') ▲

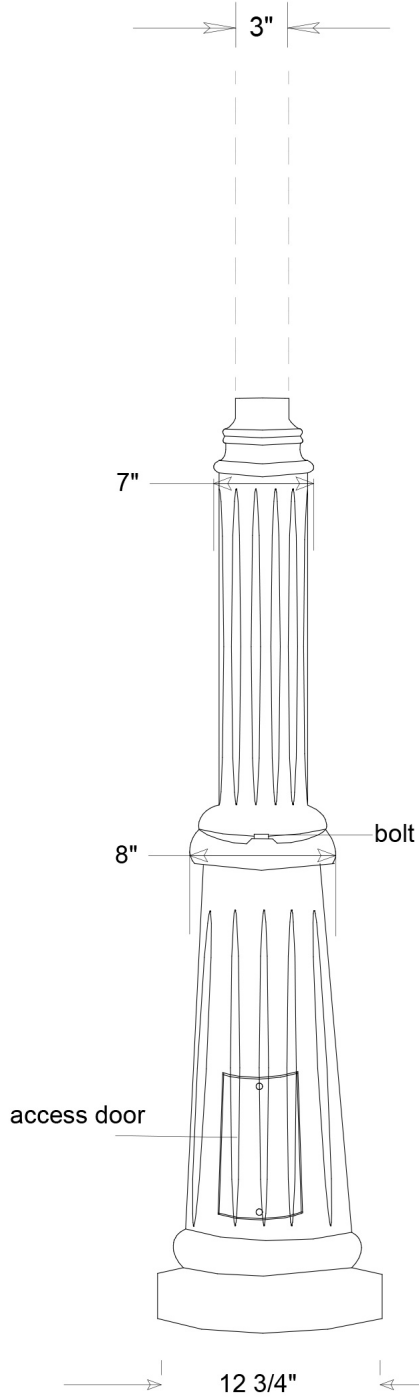
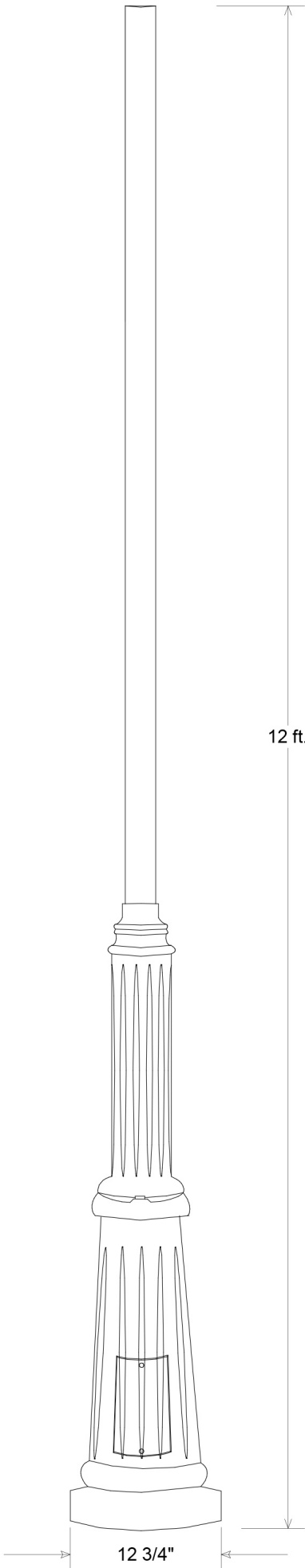

**Post Base
10" bolt circle**

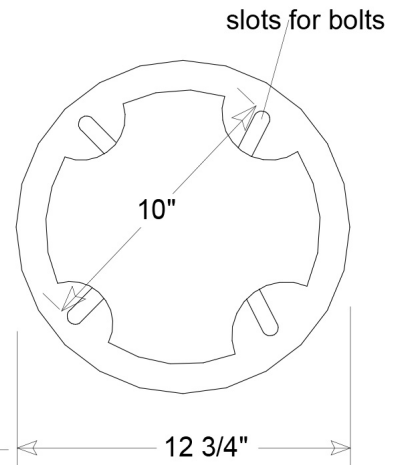

	Name	Date
Drawn	Iv	02/16/17
Checked		
ENG Appr.		
MFR Appr.		
QA		
Comments		
CAD Generated Drawing Do Not Manually Update		
Construction: All Aluminum		
10" bolt circle base		

Primelite Mfg Corp 516-868-4411		
#8812 Post		
Cast Aluminum Base Extruded Aluminum Top Smooth Height 12' Gauge .050		
Size	Drawing No.	Rev
A	0001	A
Scale	CAD File	Sheet
		1 of 1