



Primelite Manufacturing Corp

407 S Main St, Freeport, NY 11520

Phone: 516-868-4411 | Fax: 516-868-4609
 sales@primelite-mfg.com | www.primelite-mfg.com

PART # #23/16 S LED 32	LAMP Built-In LED	VOLTAGE 120 V	COLOR Powder Coated Paint
JOB NAME			TYPE Pendant

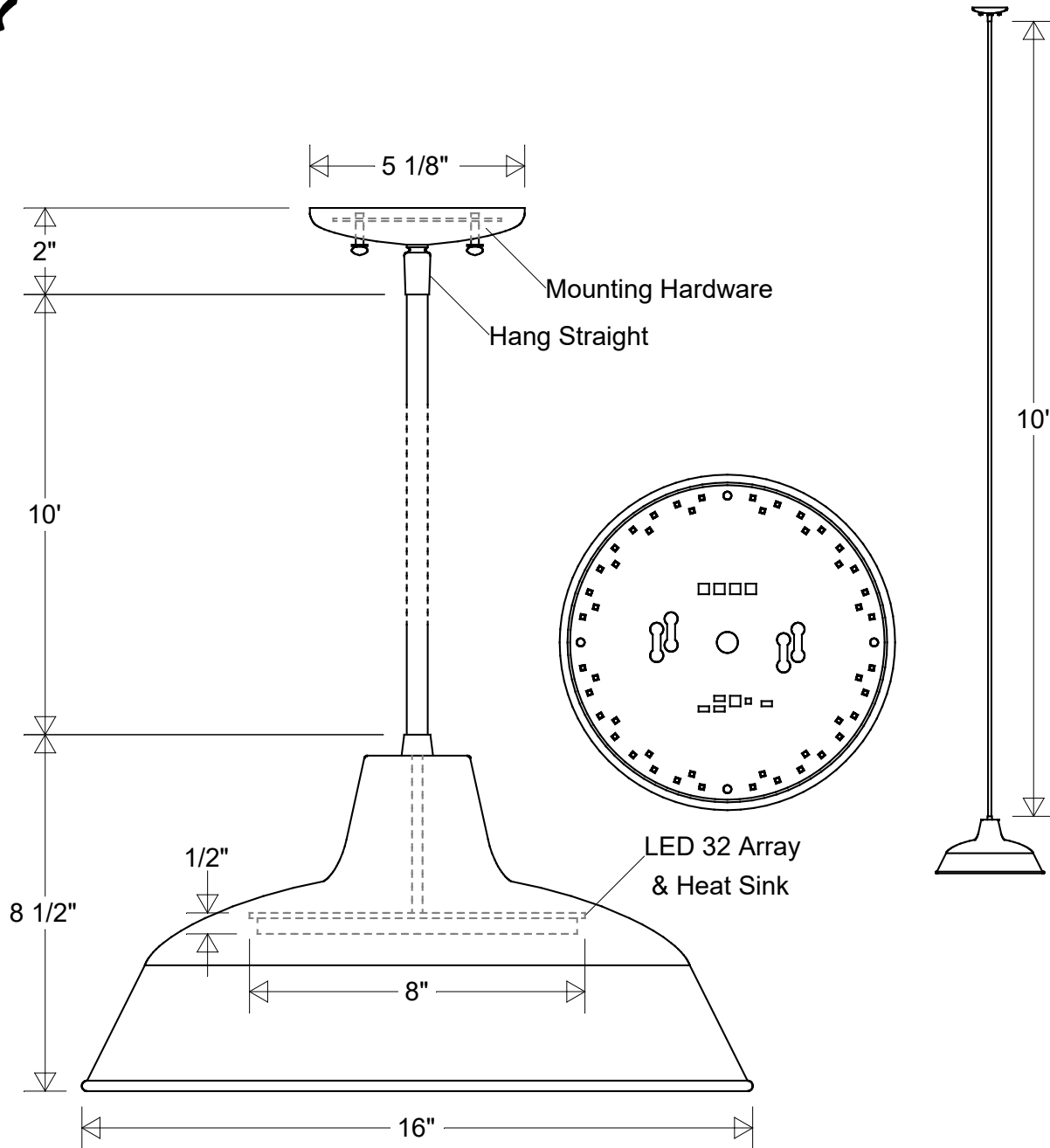

Lamp: LED 32 Array
 200 W Inc Equivalent
 3K = 2700 Lumens
 4K = 2750 Lumens



	Initials	Date
Drawn	CB	02/2023
Checked		
ENG Appr.		
MFR Appr.		
QA		

#23/16 S Special LED 32

16" Dia | 8 1/2" H | 10' x 1/4" IPS Stem

Construction:
Aluminum

Size	Drawing No.	Rev
A	0001	A

Unless Otherwise Specified:
Dimensions in Inches

Weight:	Scale	CAD File	Sheet
			1 of 1

Revisions				
Zone	Rev	Description	Date	Appr