

Revisions				
Zone	Rev	Description	Date	Approved

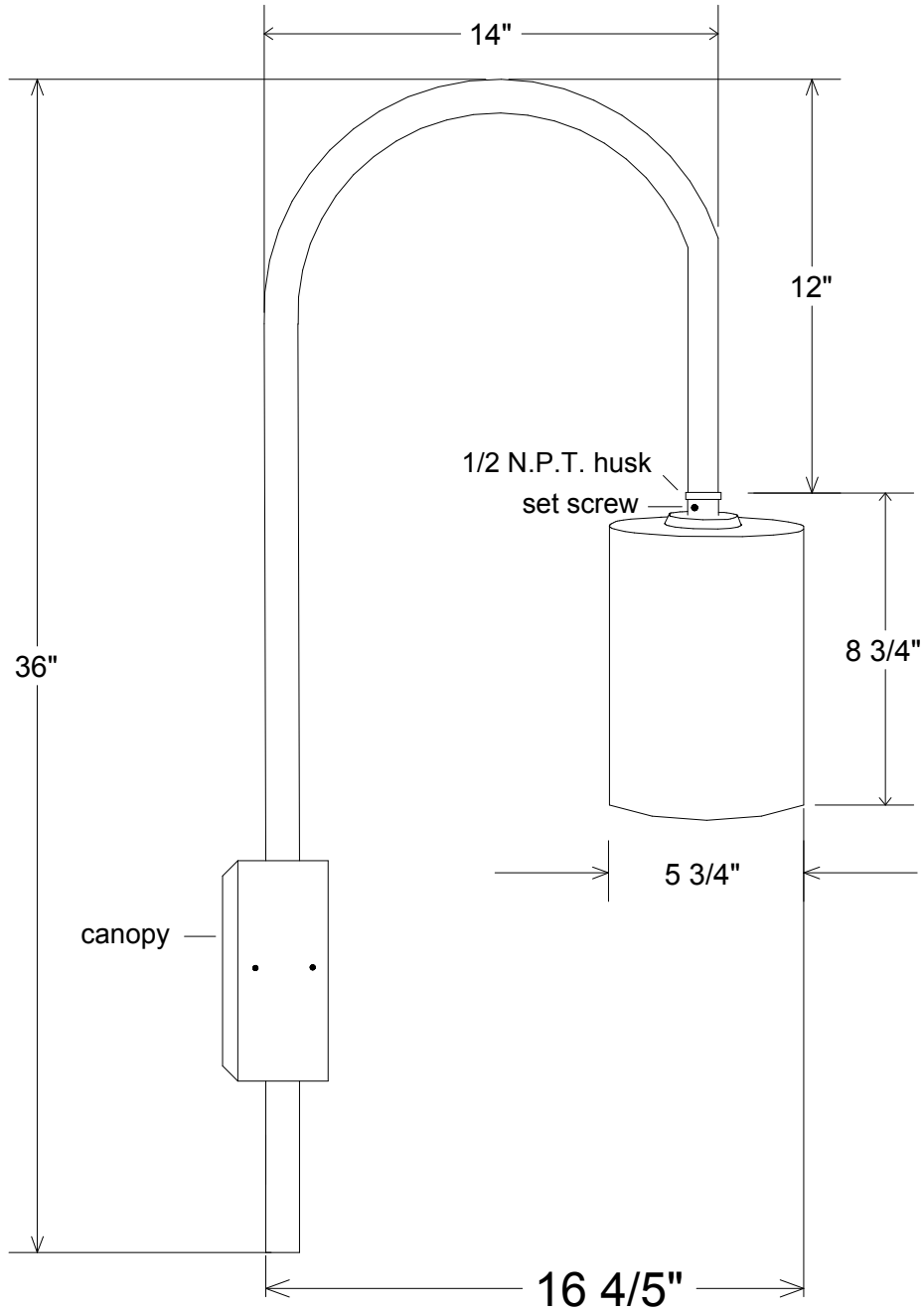

Unless Otherwise Specified: Dimensions in Inches Tolerances: Fractional ± Angular: Mach ± Bend ± Two Place Decimal ± Three Place Decimal ±	Drawn	T.A.R.	11/03/09	Primelite Mfg. Corp.		
	Checked					
	ENG Appr.			Size	Drawing No.	Rev
	MFR Appr.			A	0001	A
	QA			Scale	CAD File	Sheet
	Comments	CAD Generated Drawing Do Not Manually Update			1:6	
Construction: All Aluminum						
Pipe Size: 1/2"						
Lamp: 1-150A						