



Primelite Manufacturing Corp.

407 S Main St, Freeport, NY 11520
 Phone: (516) 868-4411 | Fax: (516) 868-4609
 sales@primelite-mfg.com | www.primelite-mfg.com

PROUDLY MADE IN THE USA SINCE 1962!
"SPECIALTIES ARE OUR SPECIALTY!"

Job Info

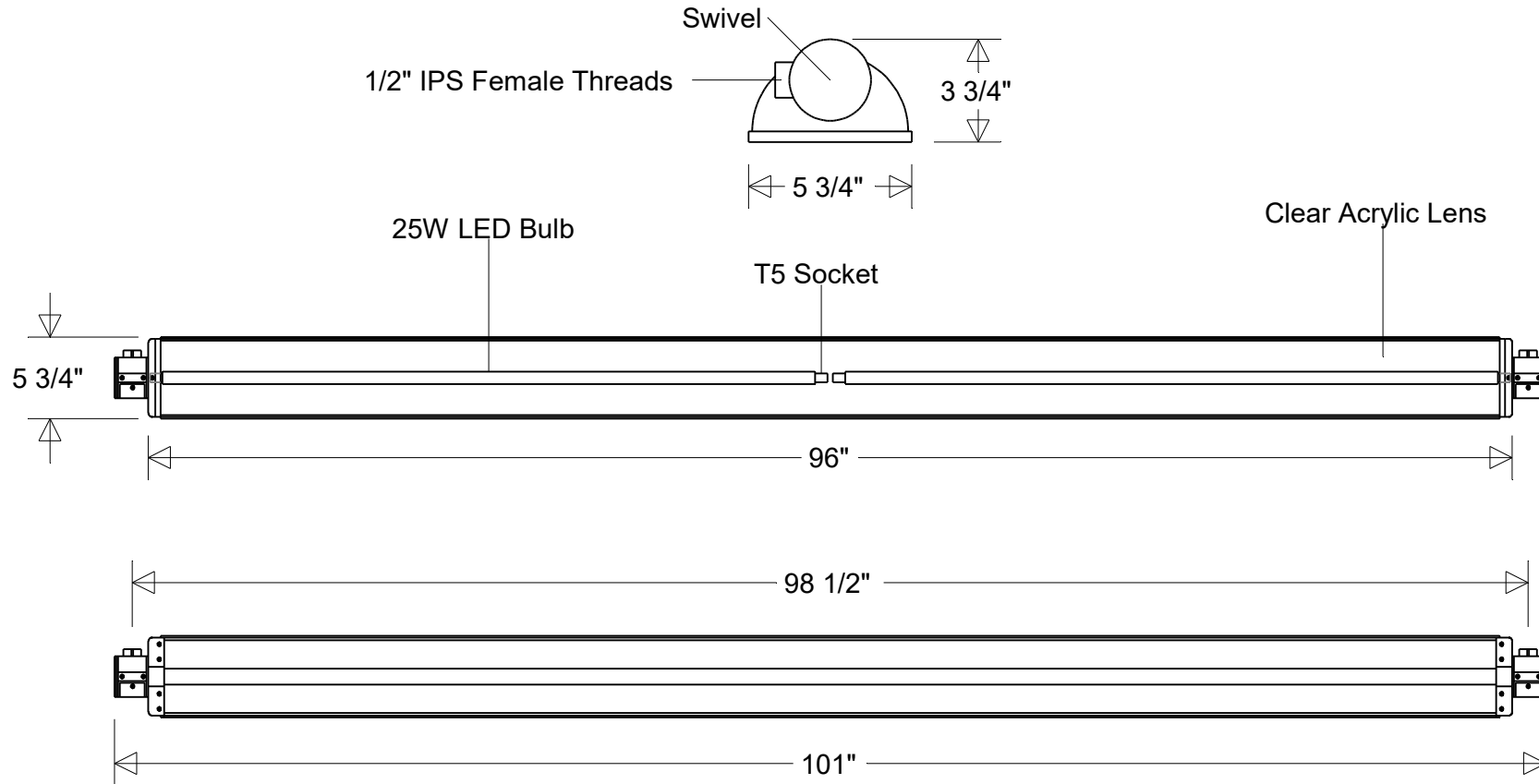

#5796 A BP LED 50

101" L | 5 3/4" W | 3 3/4" H
 98 1/2" Center to Center

Lamp: 50 W LED CCT: 35K 4K 5K 108W Fluor Equivalent	Finish: 29 Oven Baked Powder Coated Paints	Drawn: CB 05/2026	Scale: S1: 1 / 6.25 S2: 1 / 12.5	Approvals	
80 CRI 120-277 V Non-Dimming	Material: Aluminum Clear Acrylic Lens	Note: All dimensions are nominal. Actual dimensions may vary.			