



Primelite Manufacturing Corp

407 S Main St, Freeport, NY 11520

Phone: 516-868-4411 | Fax: 516-868-4609
 sales@primelite-mfg.com | www.primelite-mfg.com

PART # #5751/852 ESW LED 50	LAMP Built-In LED	VOLTAGE 120 - 277 V	COLOR Powder Coated Paint
JOB NAME			TYPE Linear Sign Light

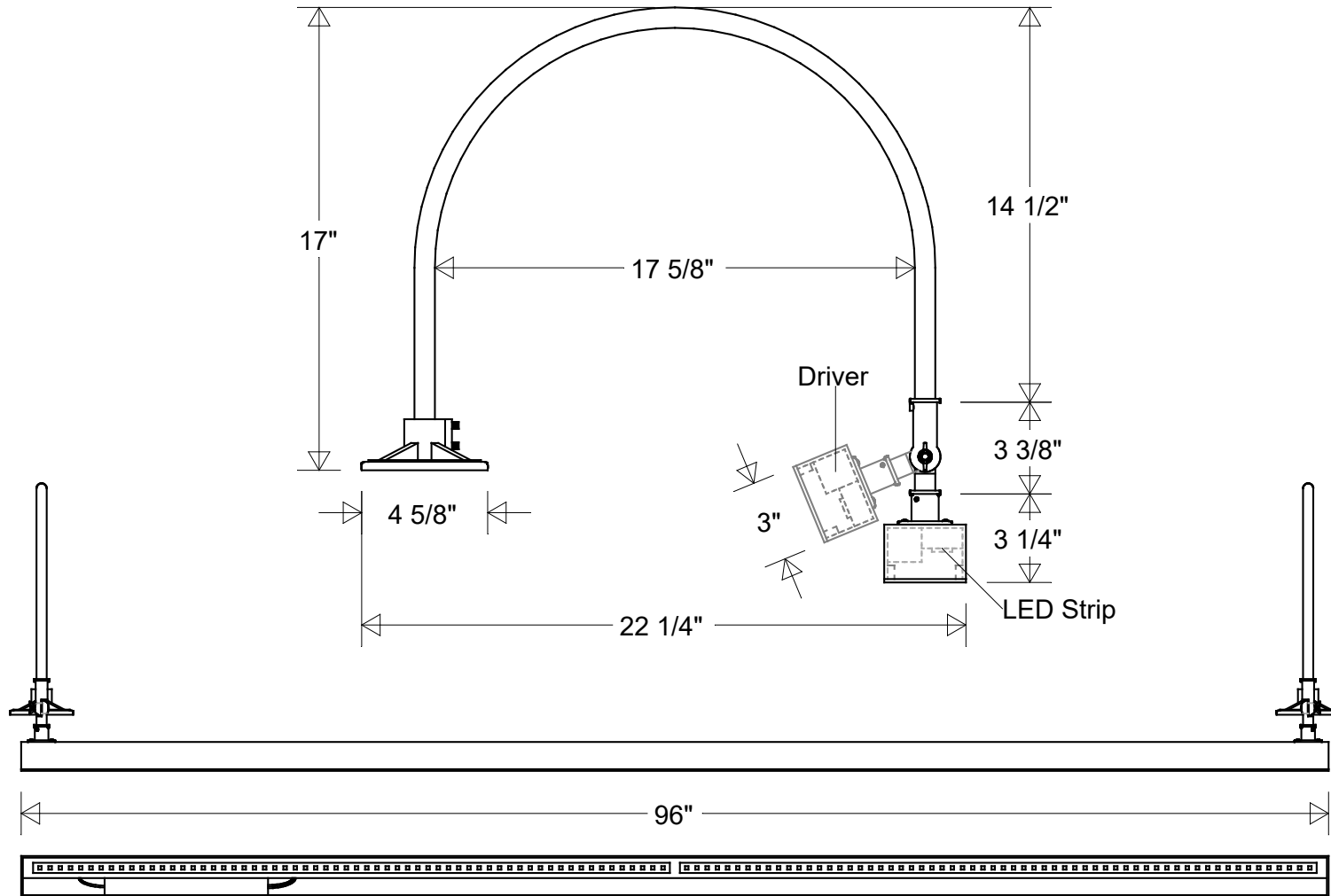

Lamp: LED 50 Strip
 35K = 7795 Lumens
 5K = 7795 Lumens



Construction:
 Aluminum | Acrylic

Unless Otherwise Specified:
 Dimensions in Inches

	Initials	Date
Drawn	CB	03/2022
Checked		
ENG Appr.		
MFR Appr.		
QA		

Sign Light #5751/852 ESW LED 50

97 5/8" L | 22 1/4" Ext | 21 1/8" H | 93" Center to Center Arms

Acrylic Lens: White (-3) | Clear (-4) | Frosted (-5)

Size	Drawing No.	Rev
A	0001	A

Scale	CAD File	Sheet
		1 of 1

Revisions				
Zone	Rev	Description	Date	Appr