



# Primelite Manufacturing Corp.

407 S Main St, Freeport, NY 11520  
 Phone: (516) 868-4411 | Fax: (516) 868-4609  
 sales@primelite-mfg.com | www.primelite-mfg.com

**PROUDLY MADE IN THE USA SINCE 1962!**  
**"SPECIALTIES ARE OUR SPECIALTY!"**

Job Info

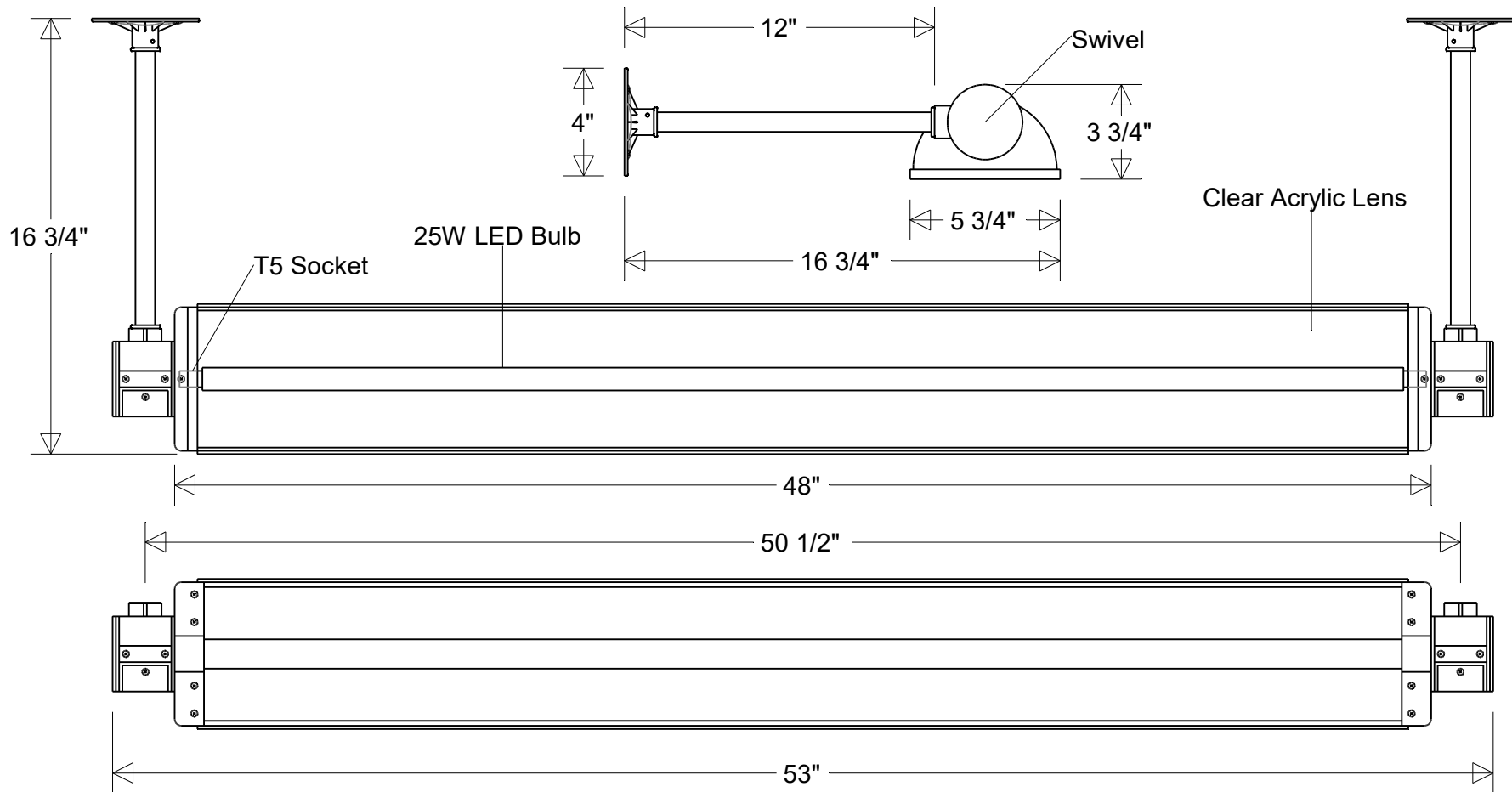

## #5748 BP LED 25

53" L | 16 3/4" Ext | 12" x 1/2" IPS Arms  
 50 1/2" Center to Center

<b>Lamp: 25 W LED</b> CCT: 35K   4K   5K 54W Fluor Equivalent	<b>Finish:</b> 29 Oven Baked Powder Coated Paints	<b>Drawn:</b> CB	<b>Scale:</b> 1 / 6.25	<b>Approvals</b>	
80 CRI 120-277 V Non-Dimming	<b>Material:</b> Aluminum Clear Acrylic Lens	<b>Note:</b> All dimensions are nominal. Actual dimensions may vary.			