



Primelite Manufacturing Corp

407 S Main St, Freeport, NY 11520

Phone: 516-868-4411 | Fax: 516-868-4609
 sales@primelite-mfg.com | www.primelite-mfg.com

PART # #487	LAMP Incandescent LED	VOLTAGE 120V	COLOR Powder Coated Paint
JOB NAME			TYPE Ellipsoid Globe Pendant

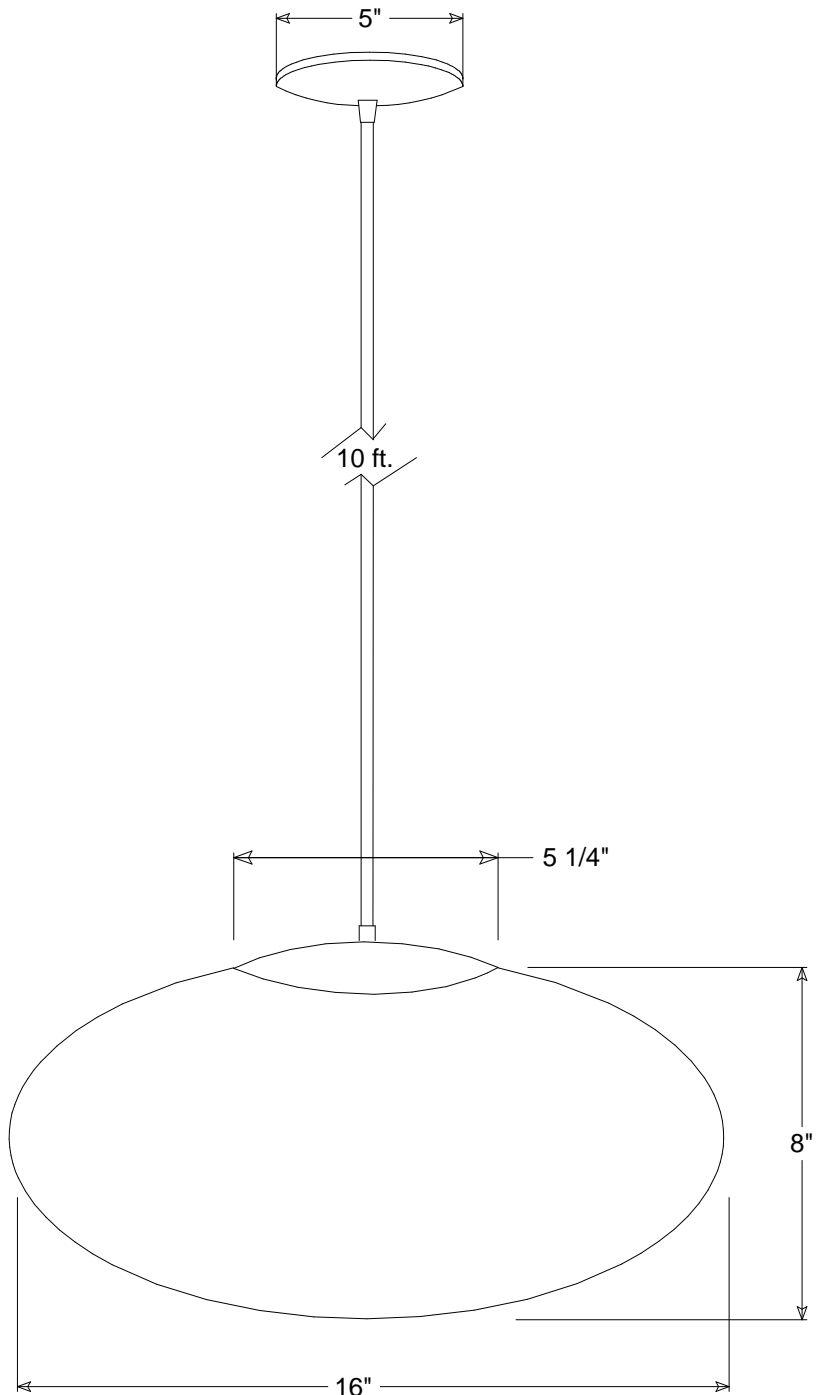

Lamp: Incandescent | LED

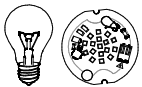

1/60A | LED12 3K

Construction: Aluminum
Polyethelene

Unless Otherwise Specified:
Dimensions in Inches

Name	Date	Globe Pendant #487		
Drawn iv	10/02/18	16" x 8" Ellipsoid Globe 10' Vinyl Cord White Polyethelene		
Checked		Size	Drawing No.	Rev
ENG Appr.		A	0001	A
MFR Appr.		Scale	CAD File	Sheet
QA				1 of 1

Revisions				
Zone	Rev	Description	Date	Approved