

Revisions				
Zone	Rev	Description	Date	Approved

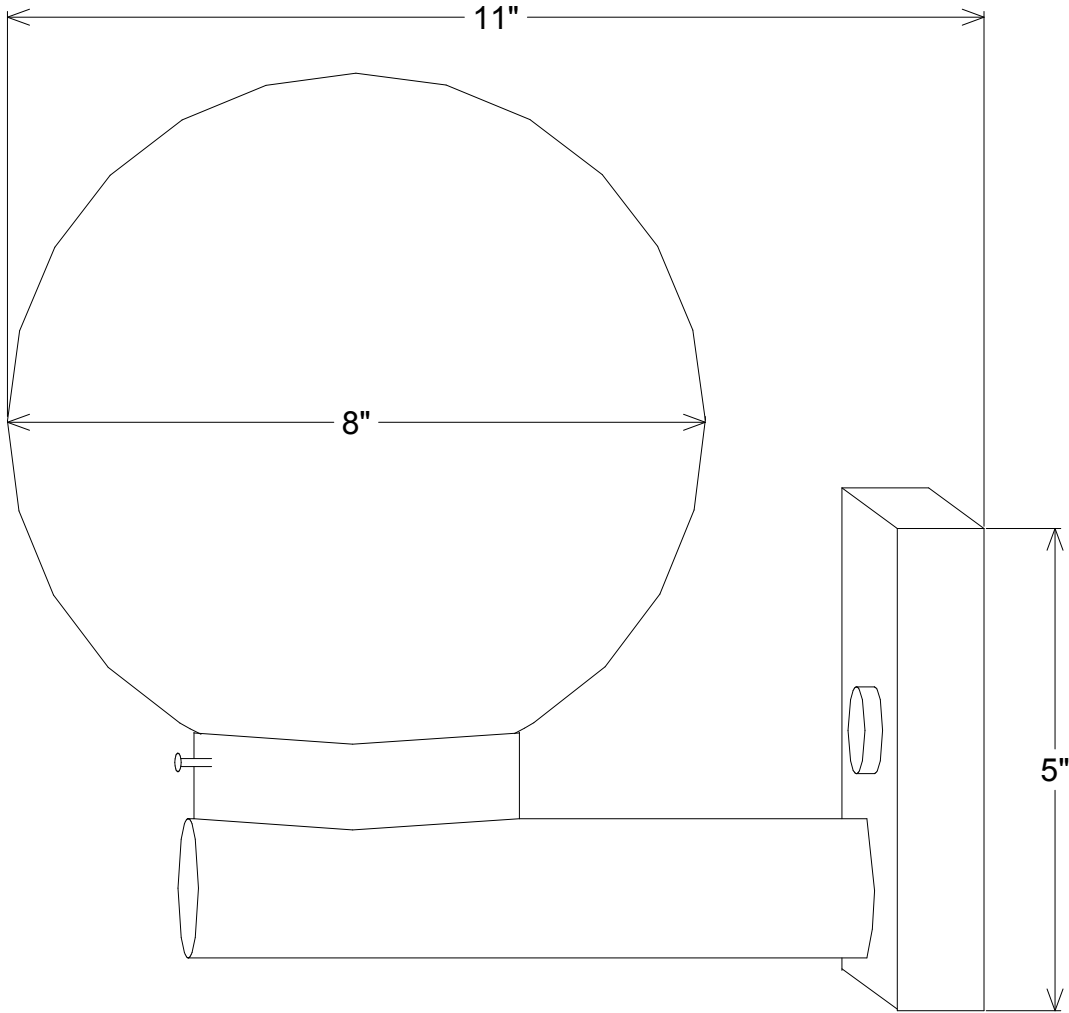

Unless Otherwise Specified:

Dimensions in Inches
Tolerances: Fractional ±
Angular: Mach ± Bend ±
Two Place Decimal ±
Three Place Decimal ±

**Construction: Aluminum,
Polyethylene**

Lamp: 1-75A

	Name	Date
Drawn	T.A.R.	09/28/10
Checked		
ENG Appr.		
MFR Appr.		
QA		

Comments
CAD Generated Drawing
Do Not Manually Update

Primelite Mfg. Corp.

**4684
Polyethylene**

Size A	Drawing No. 0001	Rev A
Scale 1:2	CAD File	Sheet 1 of 1