

Revisions			Date	Approved
Zone	Rev	Description		

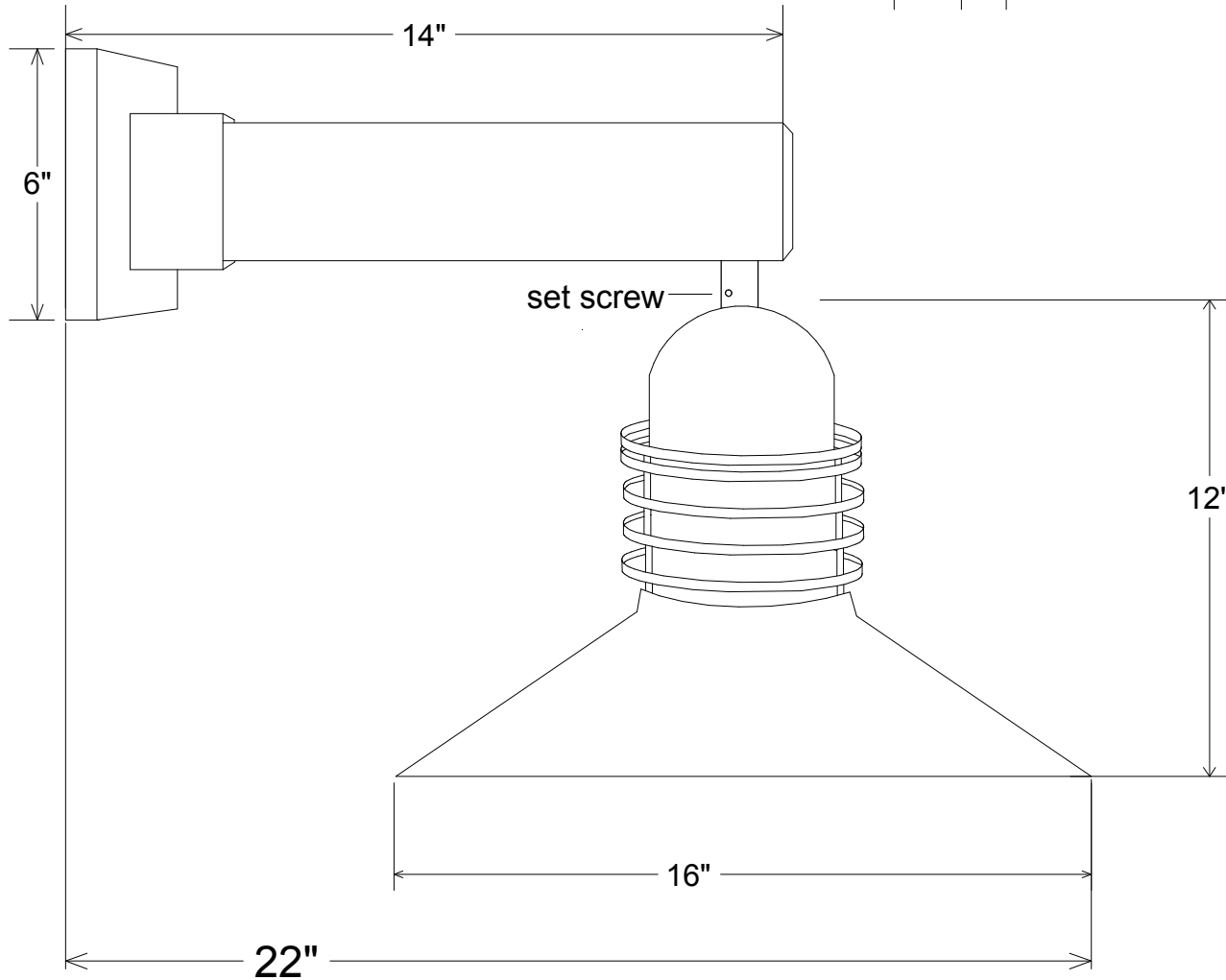

Unless Otherwise Specified: Dimensions in Inches Tolerances: Fractional ± Angular: Mach ± Bend ± Two Place Decimal ± Three Place Decimal ±	Drawn	T.A.R.	11/20/09	Primelite Mfg. Corp. 427/16-861		
	Checked					
	ENG Appr.					
	MFR Appr.					
	QA					
Construction: All Aluminum	Comments			Size	Drawing No.	Rev
Pipe Size: 1/2"	CAD Generated Drawing Do Not Manually Update			A	0001	A
Lamp: 1-100A				Scale 1:4	CAD File	Sheet 1 of 1