

Revisions			Date	Approved
Zone	Rev	Description		

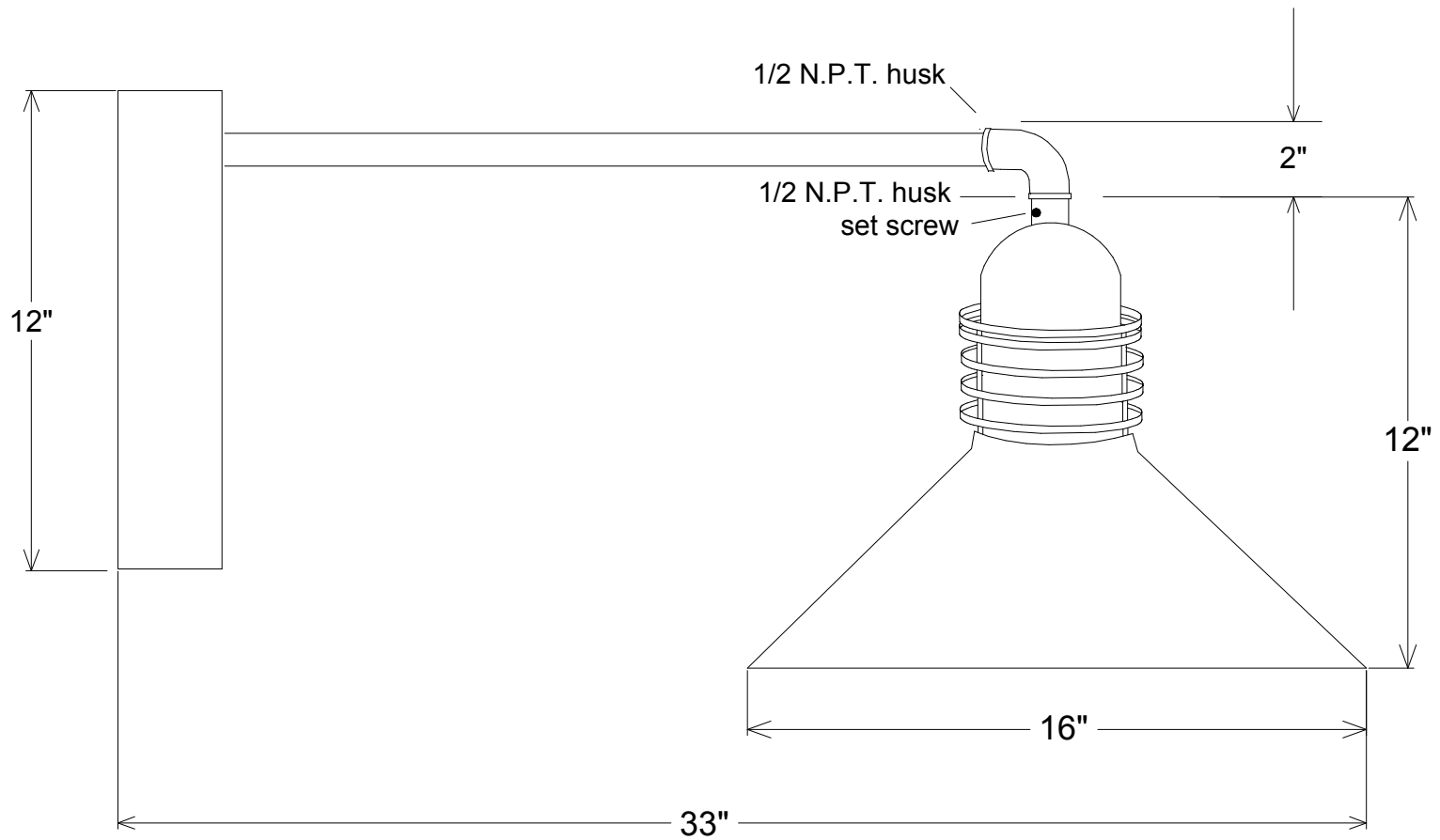

Unless Otherwise Specified: Dimensions in Inches Tolerances: Fractional ± Angular: Mach ± Bend ± Two Place Decimal ± Three Place Decimal ±		Name	Date	Primelite Mfg. Corp. 427/16-1855
	Drawn	T.A.R.	04/16/10	
	Checked			
	ENG Appr.			
	MFR Appr.			
	QA			
	Comments	CAD Generated Drawing Do Not Manually Update		
Construction: All Aluminum				Size A Drawing No. 0001 Rev A
Pipe Size: 1/2"				Scale 1:4 CAD File Sheet 1 of 1
Lamp: 1-100A				