

Revisions			Date	Approved
Zone	Rev	Description		

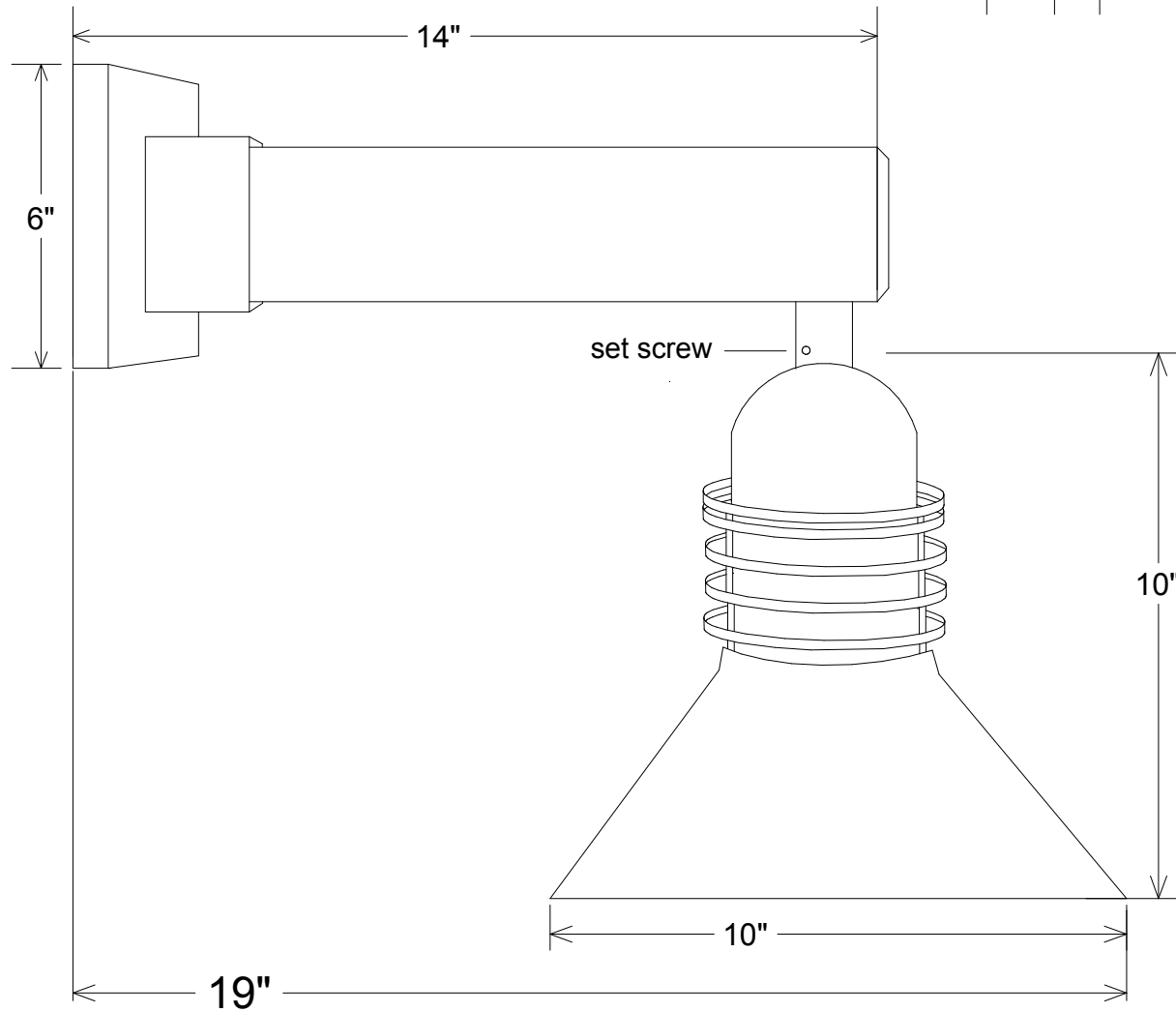

Unless Otherwise Specified: Dimensions in Inches Tolerances: Fractional ± Angular: Mach ± Bend ± Two Place Decimal ± Three Place Decimal ±	Drawn	T.A.R.	11/20/09	Primelite Mfg. Corp. 427/10-861	
	Checked				
	ENG Appr.				
	MFR Appr.				
	QA				
Construction: All Aluminum	Comments		Size A Drawing No. 0001 Rev A		
Pipe Size: 1/2"	CAD Generated Drawing Do Not Manually Update		Scale 1:4 CAD File Sheet 1 of 1		
Lamp: 1-100A					