



# Primelite Manufacturing Corp

407 S Main St, Freeport, NY 11520

Phone: 516-868-4411 | Fax: 516-868-4609  
 sales@primelite-mfg.com | www.primelite-mfg.com

<b>PART #</b> #41/10-18	<b>LAMP</b> Incandescent   LED	<b>VOLTAGE</b> 120 V	<b>COLOR</b> Powder Coated Paint
<b>JOB NAME</b>			<b>TYPE</b> Pendant

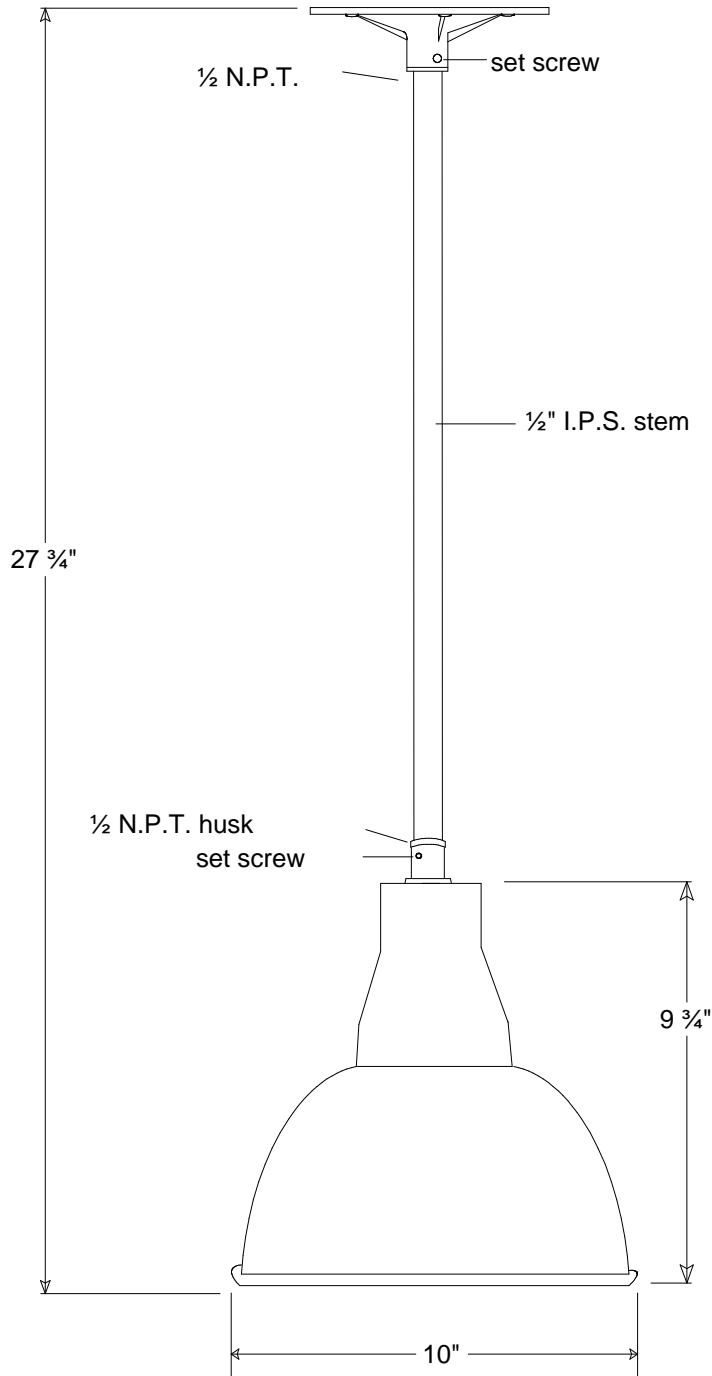

Lamp: Incandescent | LED

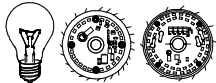

1/100A | LED12 | LED22

Construction: Aluminum

Unless Otherwise Specified:  
Dimensions in Inches

Name	Date	Pendant #41/10-18		
Drawn: iv	05/18/18	10" Dia Shade   18" Stem		
Checked:		Size: <b>A</b>	Drawing No.: <b>0001</b>	Rev: <b>A</b>
ENG Appr.:		Scale:	CAD File:	Sheet: <b>1 of 1</b>
MFR Appr.:		Comments:		
QA:				

Revisions				
Zone	Rev	Description	Date	Approved