



Primelite Manufacturing Corp.

407 S Main St, Freeport, NY 11520
 Phone: (516) 868-4411 | Fax: (516) 868-4609
 sales@primelite-mfg.com | www.primelite-mfg.com

PROUDLY MADE IN THE USA SINCE 1962!
"SPECIALTIES ARE OUR SPECIALTY!"

Job Info

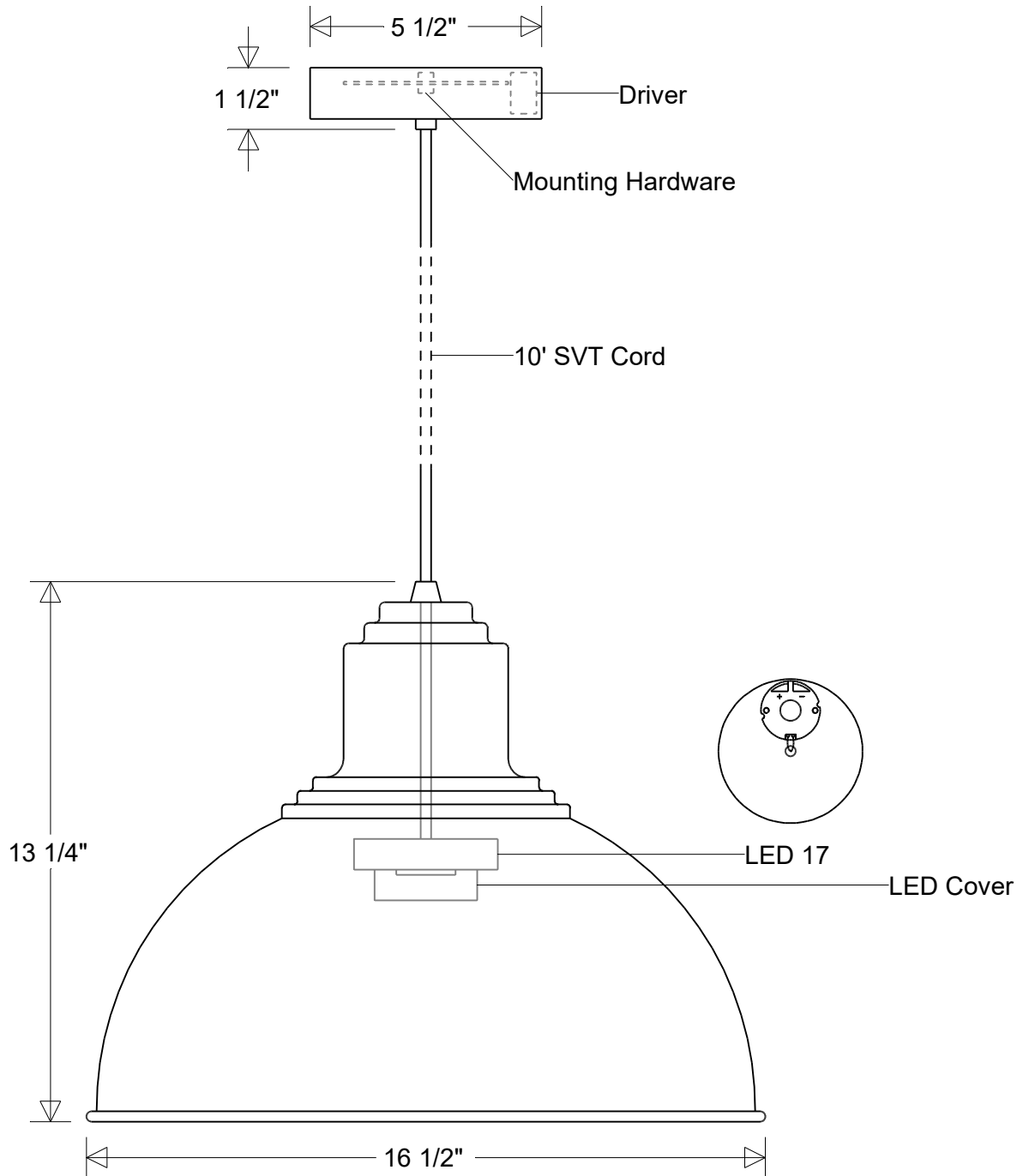

#40/16 LED 17 NonDimm

16 1/2" Dia | 13 1/4" H
 10' SVT Cord: Black / White

Lamp: 17 W LED
 CCT: 3K or 4K | Others
 150W Inc Equivalent
 80 CRI
 120-277 V
 Non-Dimming

Finish:
 29 Oven Baked
 Powder Coated Paints
Material:
 Aluminum

Drawn:
 CB
 03/2026

Scale:
 1/4

Note:
 All dimensions are nominal.
 Actual dimensions may vary.

Approvals
