

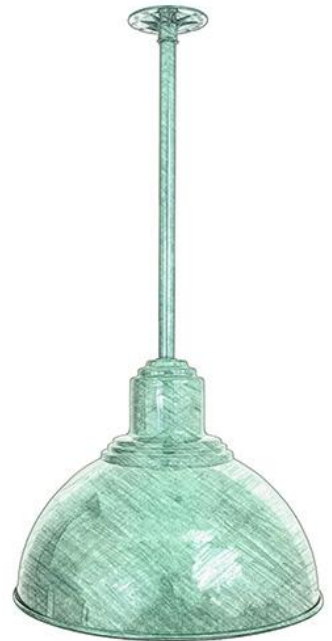

Primelite Manufacturing Corp

407 S Main St, Freeport, NY 11520
 Phone: 516-868-4411 | Fax: 516-868-4609
 sales@primelite-mfg.com | www.primelite-mfg.com

PART # #40/16-18	LAMP Incandescent LED	VOLTAGE 120 V	COLOR Powder Coated Paint
JOB NAME			TYPE Pendant

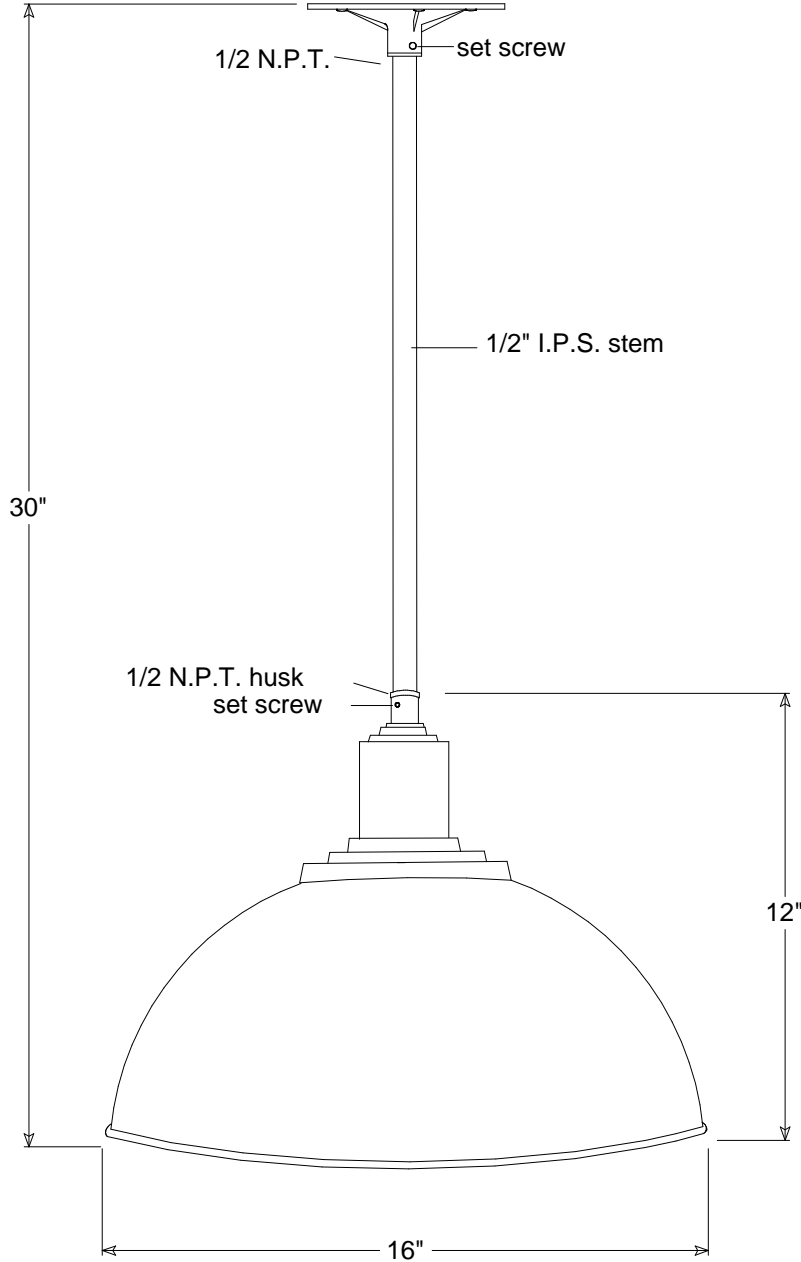

Lamp: Incandescent | LED

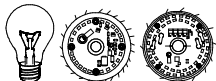

1/100A | LED12 | LED22

Construction: Aluminum

Unless Otherwise Specified:
Dimensions in Inches

Name	Date	Pendant #40/16-18		
iv	05/18/18			
Drawn		16" Dia Shade 18" Stem		
Checked				
ENG Appr.		Size	Drawing No.	Rev
MFR Appr.		A	0001	A
QA		Scale	CAD File	Sheet
Comments				1 of 1

Revisions				
Zone	Rev	Description	Date	Approved