

Revisions			Date	Approved
Zone	Rev	Description		

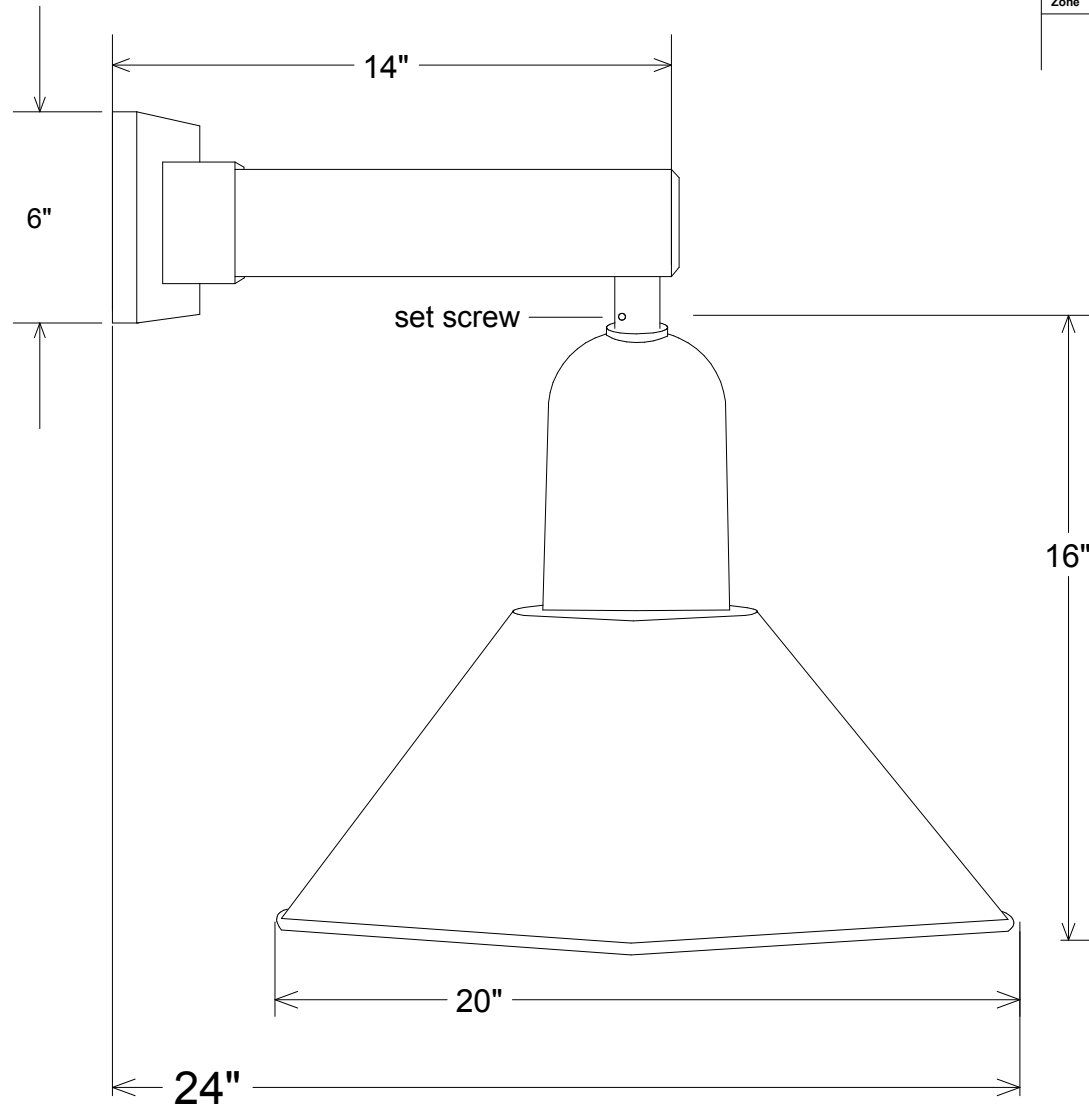

Unless Otherwise Specified: Dimensions in Inches Tolerances: Fractional ± Angular: Mach ± Bend ± Two Place Decimal ± Three Place Decimal ±	Drawn T.A.R.	Date 11/19/09	Primelite Mfg. Corp. 37-20/861		
	Checked				
	ENG Appr.				
	MFR Appr.				
	QA				
Construction: All Aluminum	Comments CAD Generated Drawing Do Not Manually Update		Size A	Drawing No. 0001	Rev A
Pipe Size: 1/2"			Scale 1:4	CAD File	Sheet 1 of 1
Lamp: 1-150A					