

Revisions			Date	Approved
Zone	Rev	Description		

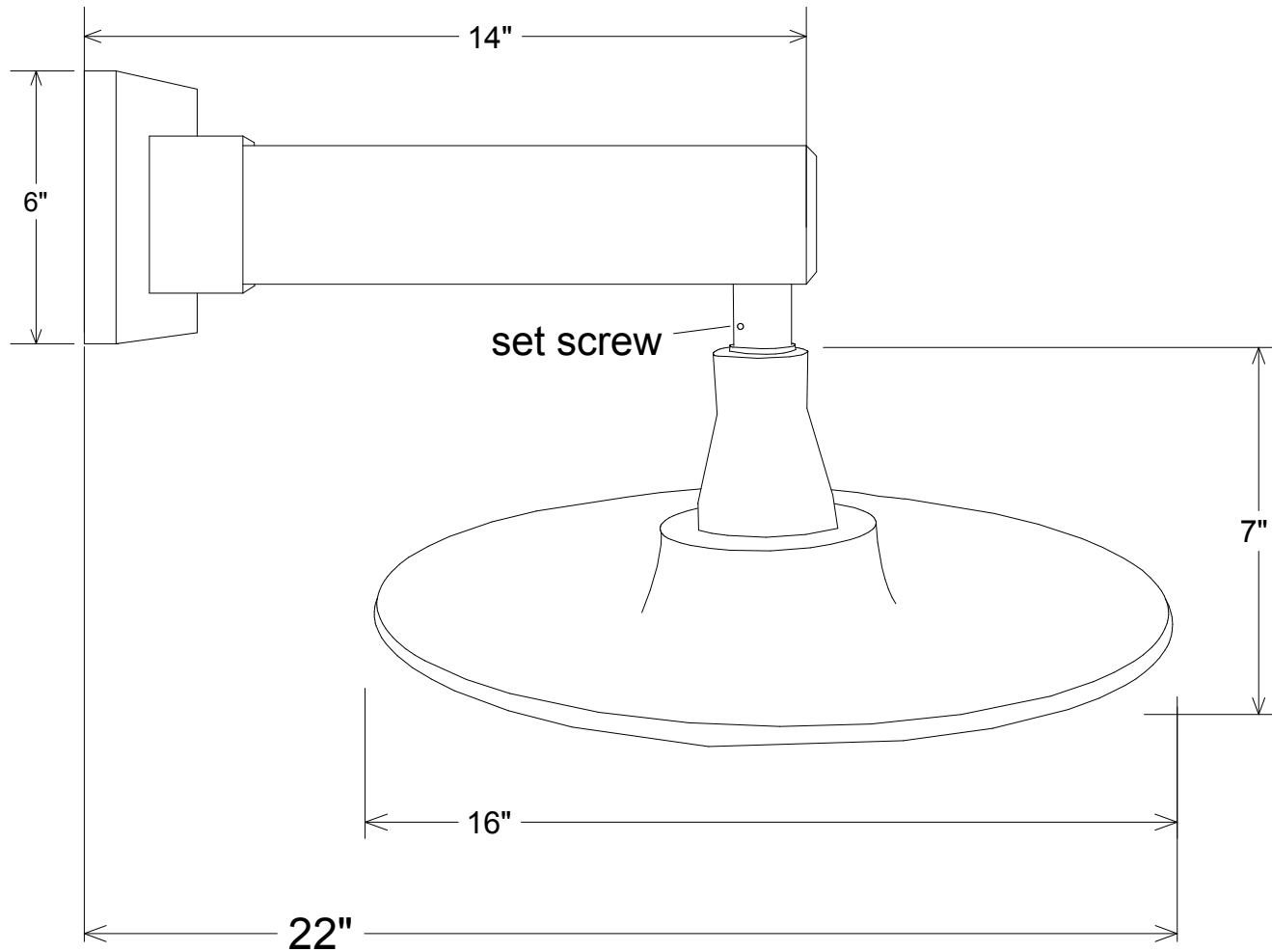

<b>Unless Otherwise Specified:</b> Dimensions in Inches Tolerances: Fractional ± Angular: Mach ± Bend ± Two Place Decimal ± Three Place Decimal ±	<b>Drawn</b> T.A.R.	<b>Date</b> 11/19/09	<b>Primelite Mfg. Corp.</b>  <b>34-16/861</b>		
	<b>Checked</b>				
	<b>ENG Appr.</b>				
	<b>MFR Appr.</b>				
	<b>QA</b>				
<b>Construction: All Aluminum</b>	<b>Comments</b> CAD Generated Drawing Do Not Manually Update		<b>Size</b> <b>A</b>	<b>Drawing No.</b> <b>0001</b>	<b>Rev</b> <b>A</b>
<b>Pipe Size: 1/2"</b>			<b>Scale</b> <b>1:4</b>	<b>CAD File</b>	<b>Sheet</b> <b>1 of 1</b>
<b>Lamp: 1-100A</b>					