

Side View

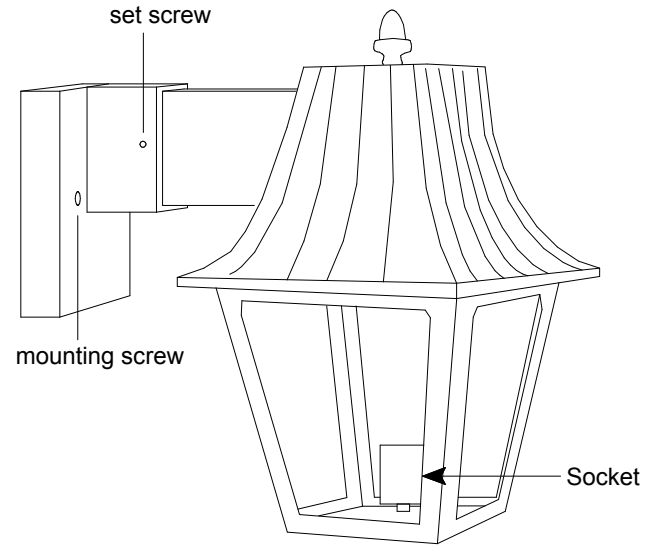

Unless Otherwise Specified:

Dimensions in Inches
 Tolerances: Fractional ±
 Angular: Mach ± Bend ±
 Two Place Decimal ±
 Three Place Decimal ±

All Aluminum Construction

Lamp: 1-150A

	Name	Date
Drawn	T.A.R.	05/27/10
Checked		
ENG Appr.		
MFR Appr.		
QA		

Comments
 CAD Generated Drawing
 Do Not Manually Update

Primelight Mfg. Corp.

3331
 Cast Aluminum Lantern
 Wall Bracket

Size	Drawing No.	Rev
A	0001	A
Scale 1:4	CAD File	Sheet 1 of 1