



Primelite Manufacturing Corp

407 S Main St, Freeport, NY 11520

Phone: 516-868-4411 | Fax: 516-868-4609
 sales@primelite-mfg.com | www.primelite-mfg.com

PART # #3271	LAMP Incandescent LED	VOLTAGE 120 V	COLOR Powder Coated Paint
JOB NAME			TYPE Wall Sconce

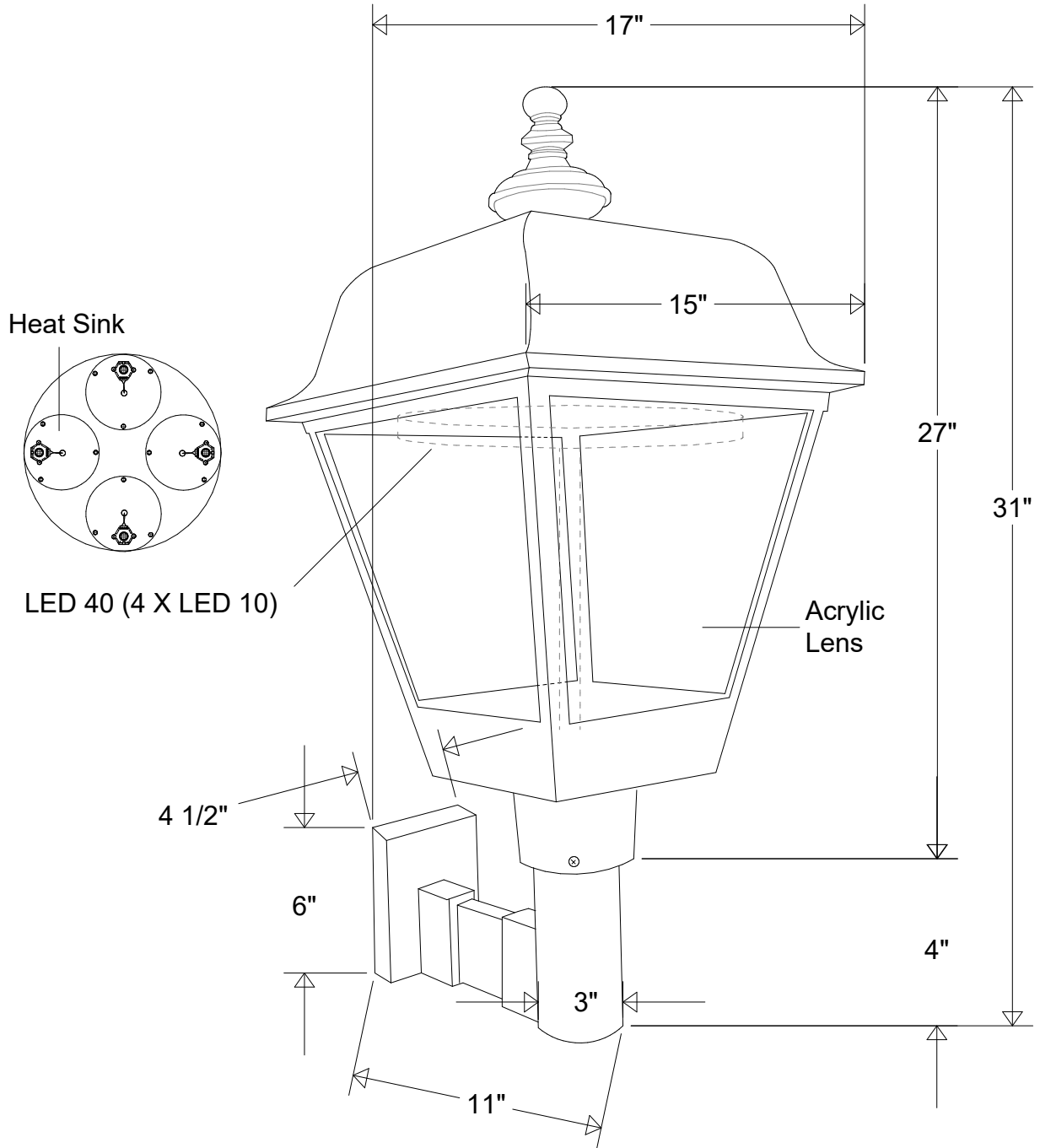

Lamp: Incandescent LED LED 40 (4 X LED 10)	Name		Date		Wall Sconce #3271 LED 40 15" W 17" Ext 31" H Acrylic Lens Smoke White Clear Frosted							
	Drawn	CB	11/19									
	Checked				Size	Drawing No.	Rev	Revisions				
	ENG Appr.							Zone	Rev	Description	Date	Approved
Construction: Aluminum Acrylic	MFR Appr.				A	0001	A					
Unless Otherwise Specified: Dimensions in Inches	QA				Scale	CAD File	Sheet	1 of 1				