

Revisions			Date	Approved
Zone	Rev	Description		

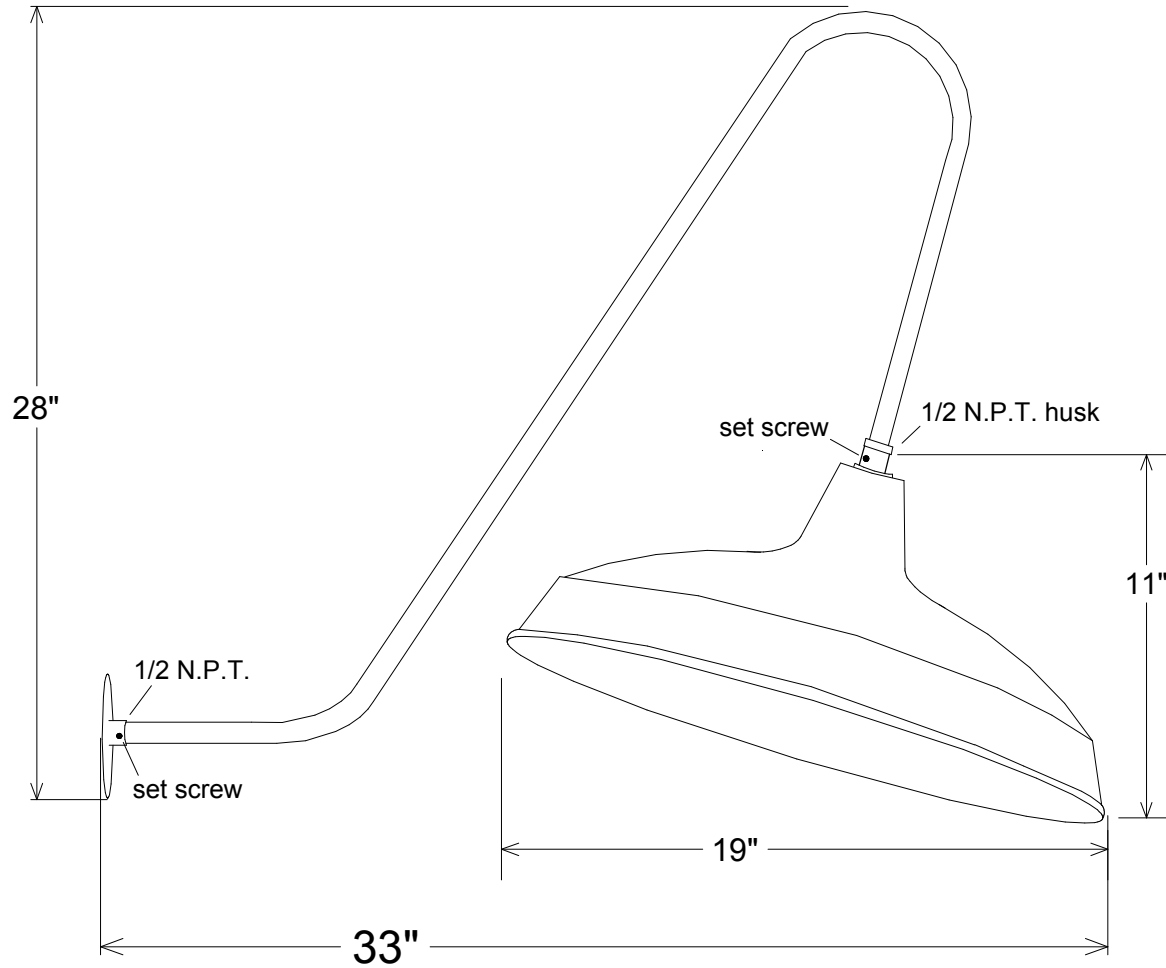

Unless Otherwise Specified: Dimensions in Inches Tolerances: Fractional ± Angular: Mach ± Bend ± Two Place Decimal ± Three Place Decimal ±	Drawn T.A.R.	Name T.A.R.	Date 12/16/09	Primelite Mfg. Corp. 23/19-869	
	Checked ENG Appr.				
	MFR Appr. MFR Appr.				
	QA QA				
	Comments CAD Generated Drawing Do Not Manually Update				
Construction: All Aluminum	Size A	Drawing No. 0001	Rev A		
Pipe Size: 1/2"	Scale 1:7	CAD File	Sheet 1 of 1		
Lamp: 1-200A					