

Small Ballast Pot Canopy

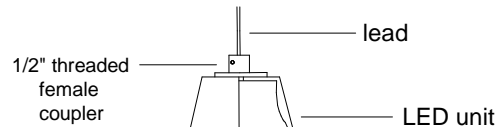
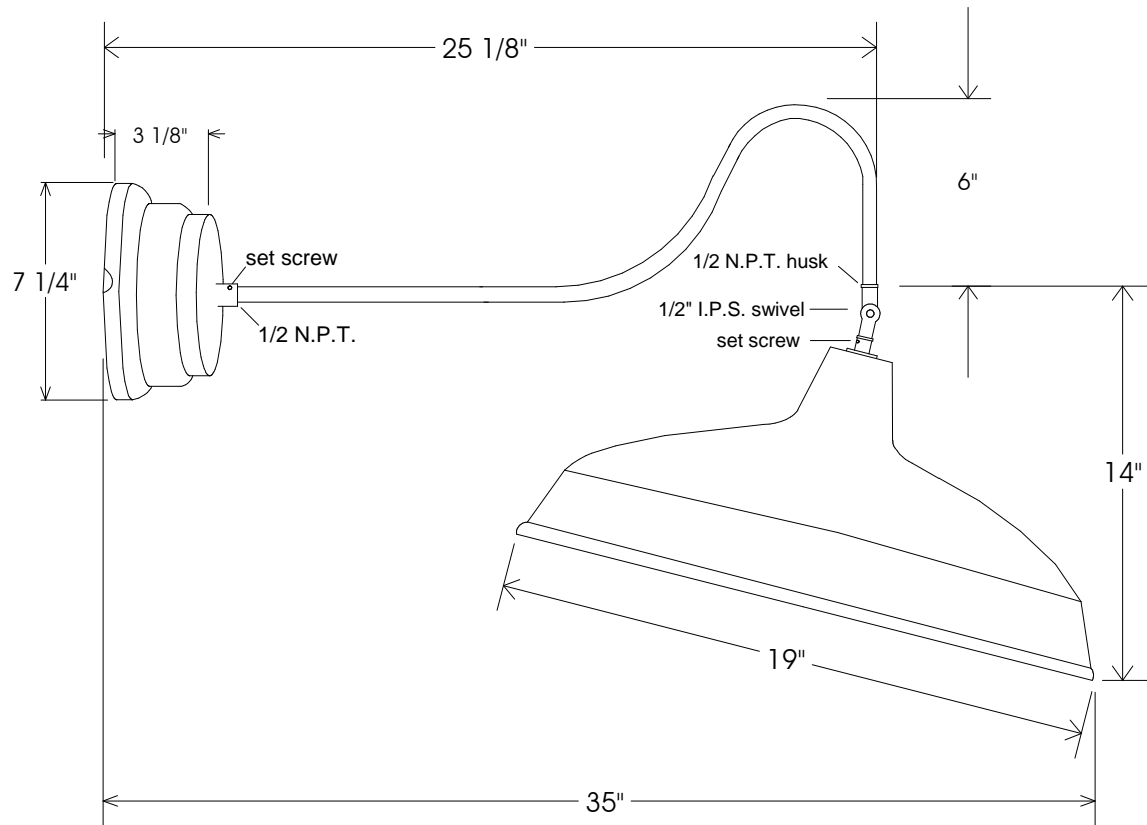
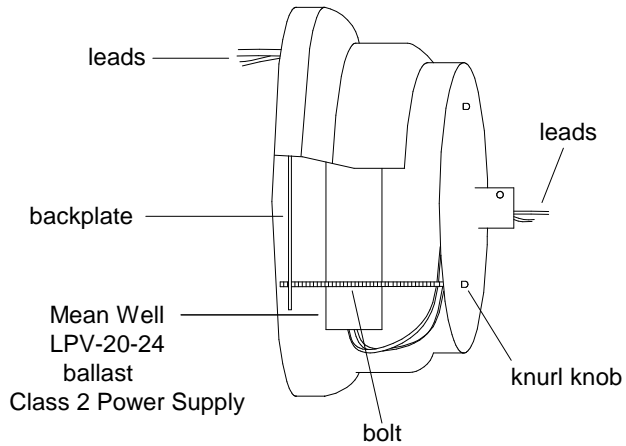

23/19A Shade

- 50,000 hour life
- Average savings is \$39.42 per year as compared to a 75 Watt incandescent
- Savings of \$ 518.16 for the life of the fixture
- Lumen output is equal to a 75 Watt bulb.

Unless Otherwise Specified:				Primelite Mfg. Corp.			
Dimensions in Inches		Drawn	Name			Date	
Tolerances: Fractional ±		Checked	T.A.R.	02/07/12	23/19-853 LED 24 Watt 1000 Lumens @ 3000K 1250 Lumens @ 4000K 24 Volt Output		
Angular: Mach ± Bend ±		ENG Appr.					
Two Place Decimal ±		MFR Appr.					
Three Place Decimal ±		QA					
		Comments					
Construction: All Aluminum		CAD Generated Drawing Do Not Manually Update			Size	Drawing No.	Rev
Pipe Size: 1/2"					A	0001	A
		Scale		CAD File	Sheet		1 of 1