



Primelite Manufacturing Corp

407 S Main St, Freeport, NY 11520

Phone: 516-868-4411 | Fax: 516-868-4609
 sales@primelite-mfg.com | www.primelite-mfg.com

PART # #23/19-850 HDC LED 12	LAMP Built-In LED	VOLTAGE 120 V	COLOR Powder Coated Paint
JOB NAME			TYPE Gooseneck

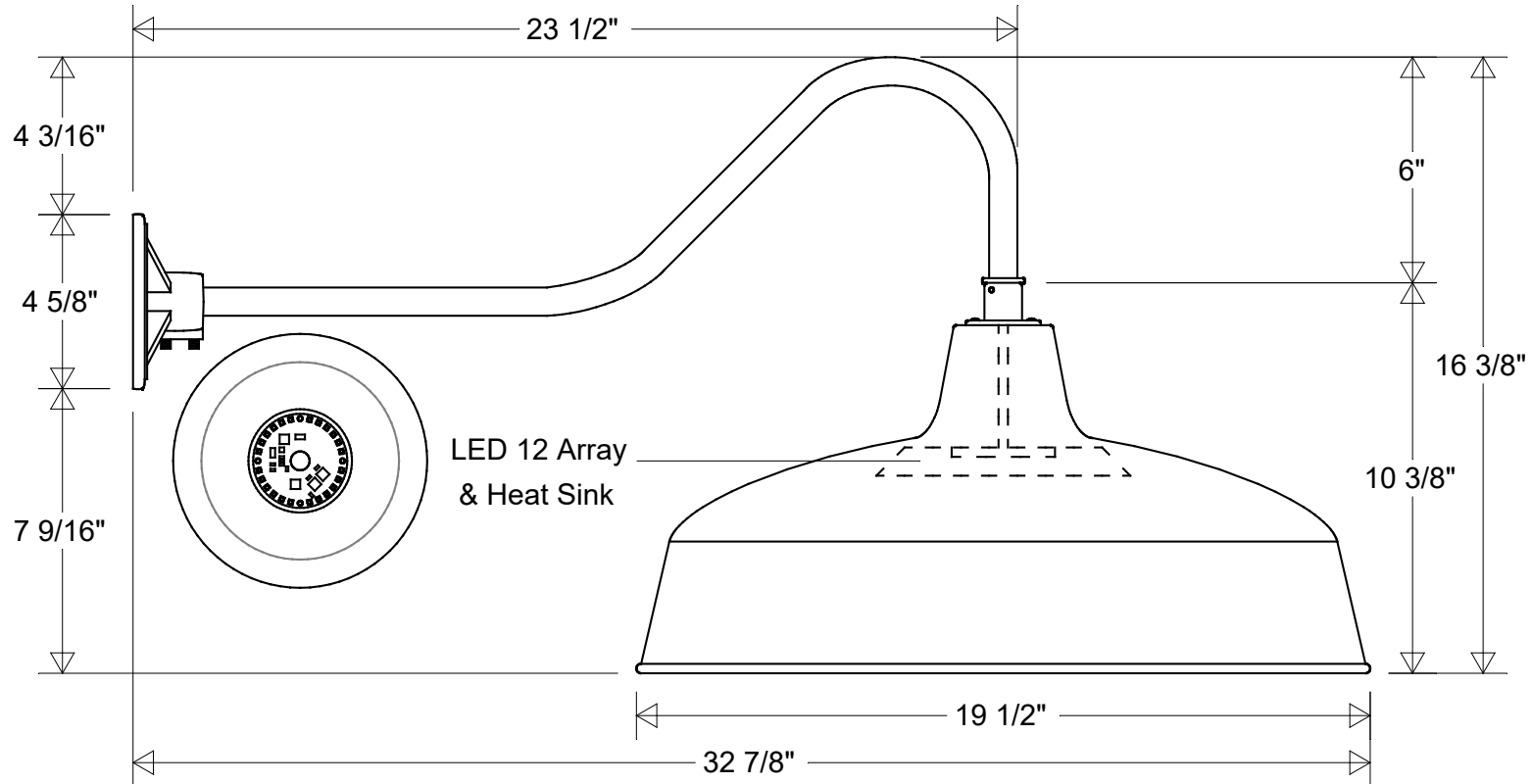

Lamp: LED 12 Array
 60 W Inc Equivalent
 3K = 910 Lumens
 4K = 1000 Lumens



	Initials	Date
Drawn	CB	02/2022
Checked		
ENG Appr.		
MFR Appr.		
QA		

Gooseneck #23/19-850 HDC LED 12

19 1/2" Dia | 32 7/8" Ext | 16 3/8" H
 6" Drop | 7 9/16" Below Box

Size	Drawing No.	Rev
A	0001	A

Revisions

Zone	Rev	Description	Date	Appr

Unless Otherwise Specified:
 Dimensions in Inches

Weight:	Scale	CAD File	Sheet
			1 of 1