



Primelite Manufacturing Corp

407 S Main St, Freeport, NY 11520

Phone: 516-868-4411 | Fax: 516-868-4609
 sales@primelite-mfg.com | www.primelite-mfg.com

PART # #23/10-850 LED 12	LAMP Built-In LED	VOLTAGE 120 V	COLOR Powder Coated Paint
JOB NAME			TYPE Gooseneck

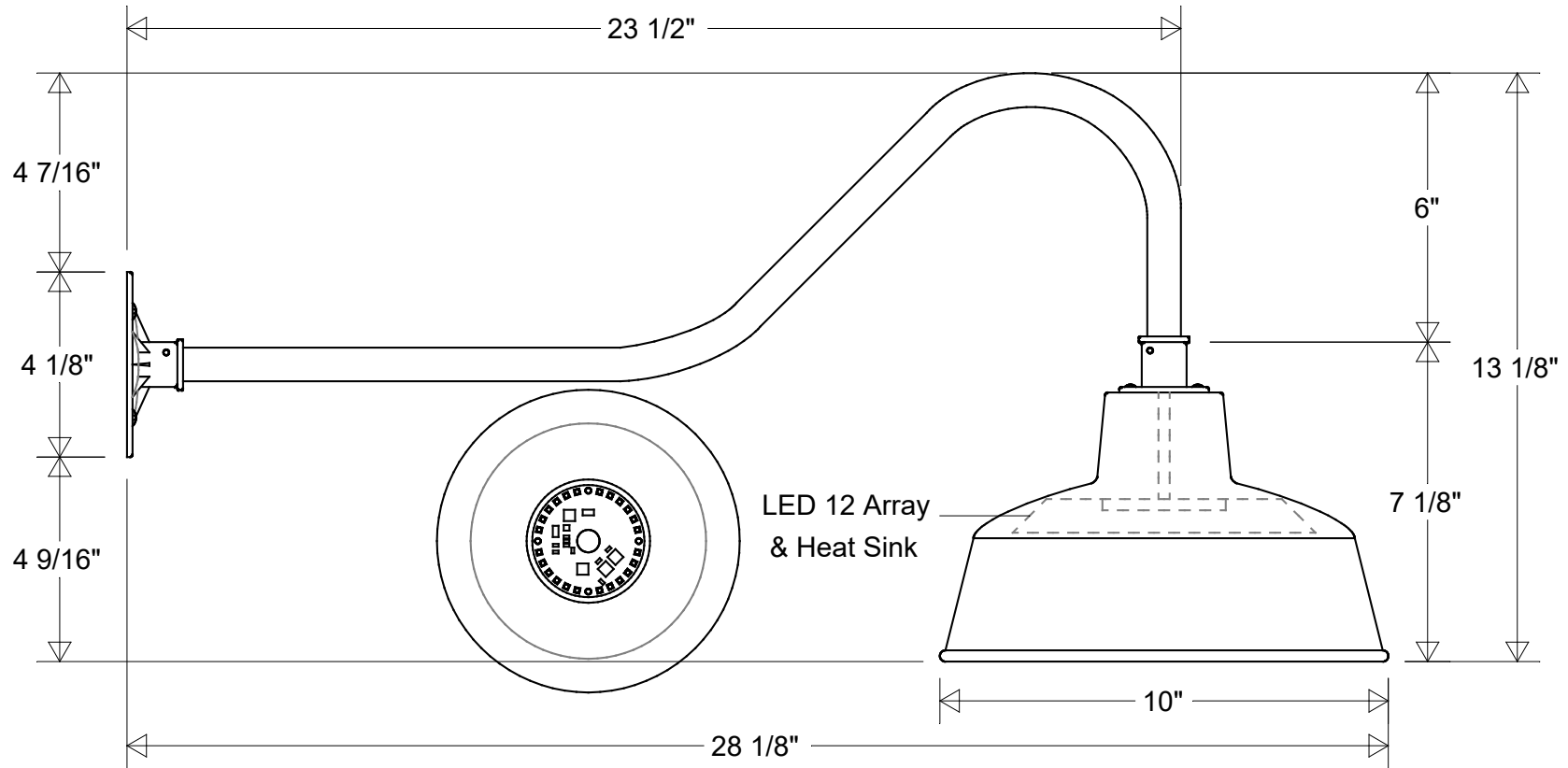

Lamp: LED 12 Array
 60 W Inc Equivalent
 3K = 910 Lumens
 4K = 1000 Lumens



	Initials	Date
Drawn	CB	05/2022
Checked		
ENG Appr.		
MFR Appr.		
QA		

Gooseneck #23/10-850 LED 12

10" Dia | 28 1/8" Ext | 13 1/8" H

6" Drop | 4 9/16" Below Box

Size	Drawing No.	Rev
A	0001	A

Revisions				
Zone	Rev	Description	Date	Appr

Construction:
Aluminum

Weight:

Scale CAD File Sheet
1 of 1