



Primelite Manufacturing Corp.

407 S Main St, Freeport, NY 11520
 Phone: (516) 868-4411 | Fax: (516) 868-4609
 sales@primelite-mfg.com | www.primelite-mfg.com

PROUDLY MADE IN THE USA SINCE 1962!
"SPECIALTIES ARE OUR SPECIALTY!"

Job Info

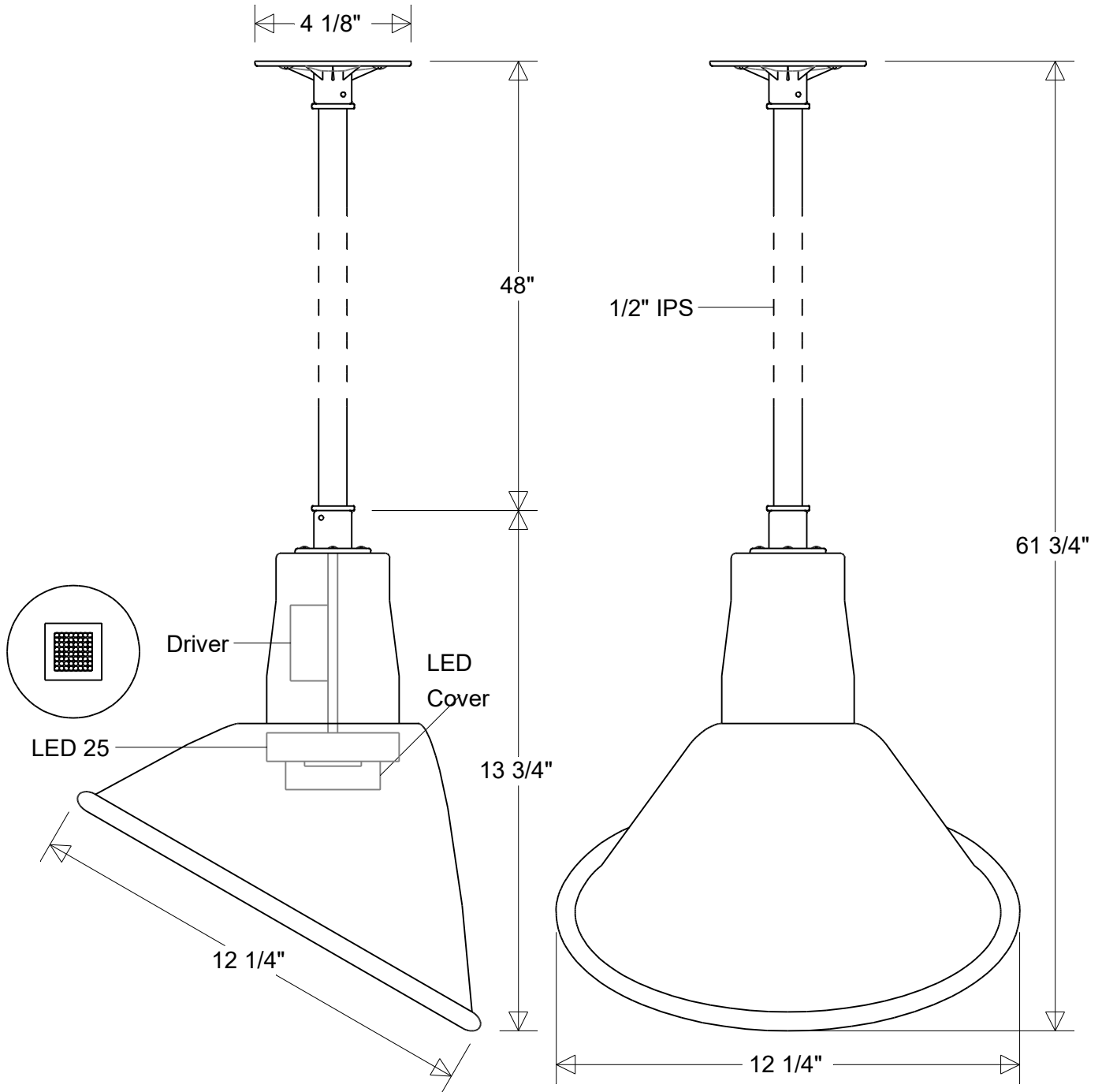

#20/12-18-48 LED 25 Dimm

12 1/4" Dia | 61 3/4" H
 48" X 1/2" IPS Stem

Lamp: 25 W LED
 CCT: 3K or 4K | Others
 50W MH Equivalent
 80 CRI
 120-277 V
 0-10 V Dimming

Finish:
 29 Oven Baked
 Powder Coated Paints
Material:
 Aluminum

Drawn:
 CB
 05/2026

Scale:
 1/4

Note:
 All dimensions are nominal.
 Actual dimensions may vary.

Approvals
