



# Primelite Manufacturing Corp.

407 S Main St, Freeport, NY 11520  
 Phone: (516) 868-4411 | Fax: (516) 868-4609  
 sales@primelite-mfg.com | www.primelite-mfg.com

**PROUDLY MADE IN THE USA SINCE 1962!**  
**"SPECIALTIES ARE OUR SPECIALTY!"**

Job Info

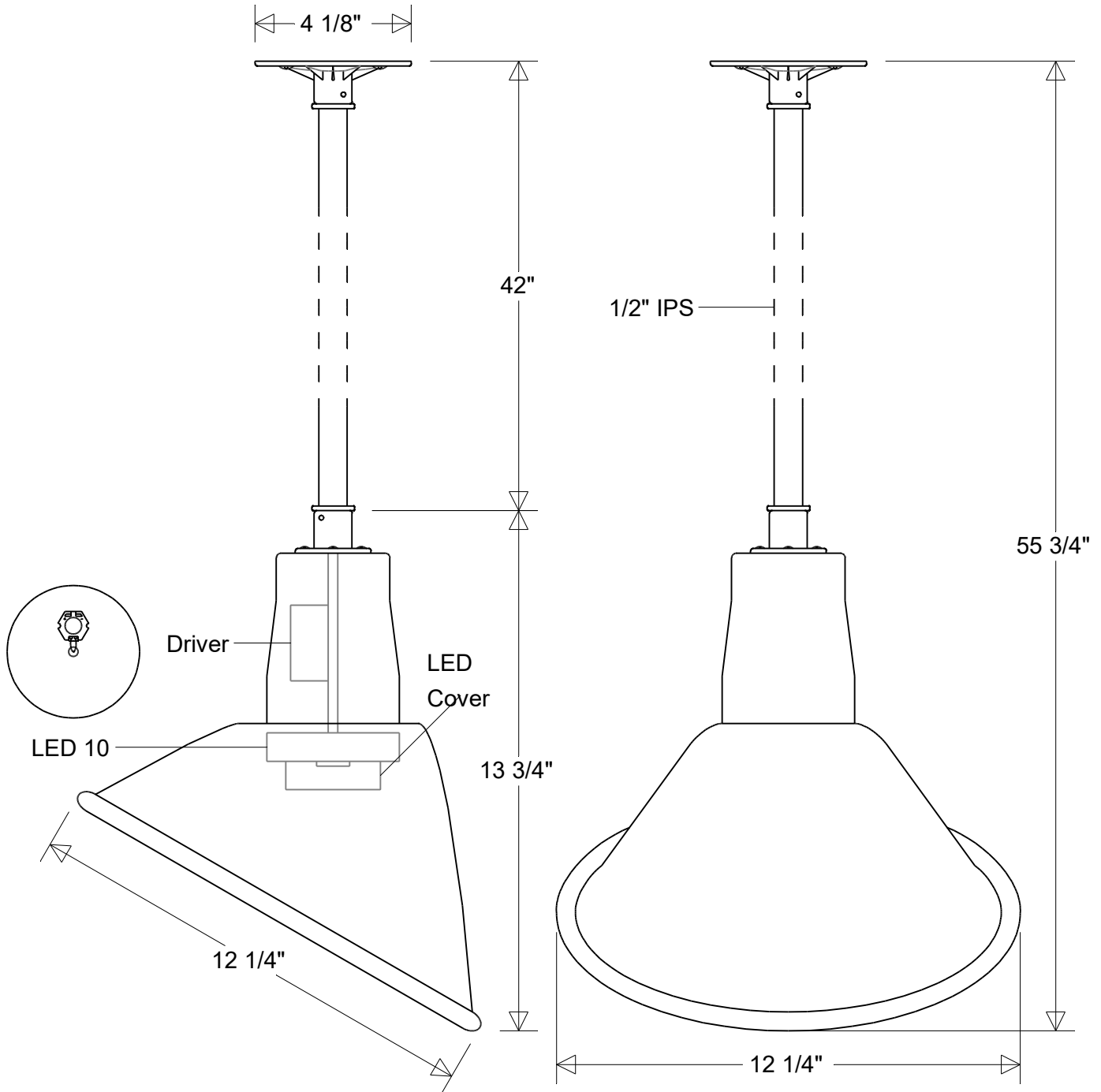

## #20/12-18-42 LED 10 NonDimm

12 1/4" Dia | 55 3/4" H  
 42" X 1/2" IPS Stem

**Lamp: 10 W LED**  
 CCT: 3K or 4K | Others  
 100W Inc Equivalent  
 80 CRI  
 120-277 V  
 Non-Dimming

**Finish:**  
 29 Oven Baked  
 Powder Coated Paints  
**Material:**  
 Aluminum

**Drawn:**  
 CB  
 05/2026

**Scale:**  
 1/4

**Note:**  
 All dimensions are nominal.  
 Actual dimensions may vary.

Approvals