

Revisions				
Zone	Rev	Description	Date	Approved

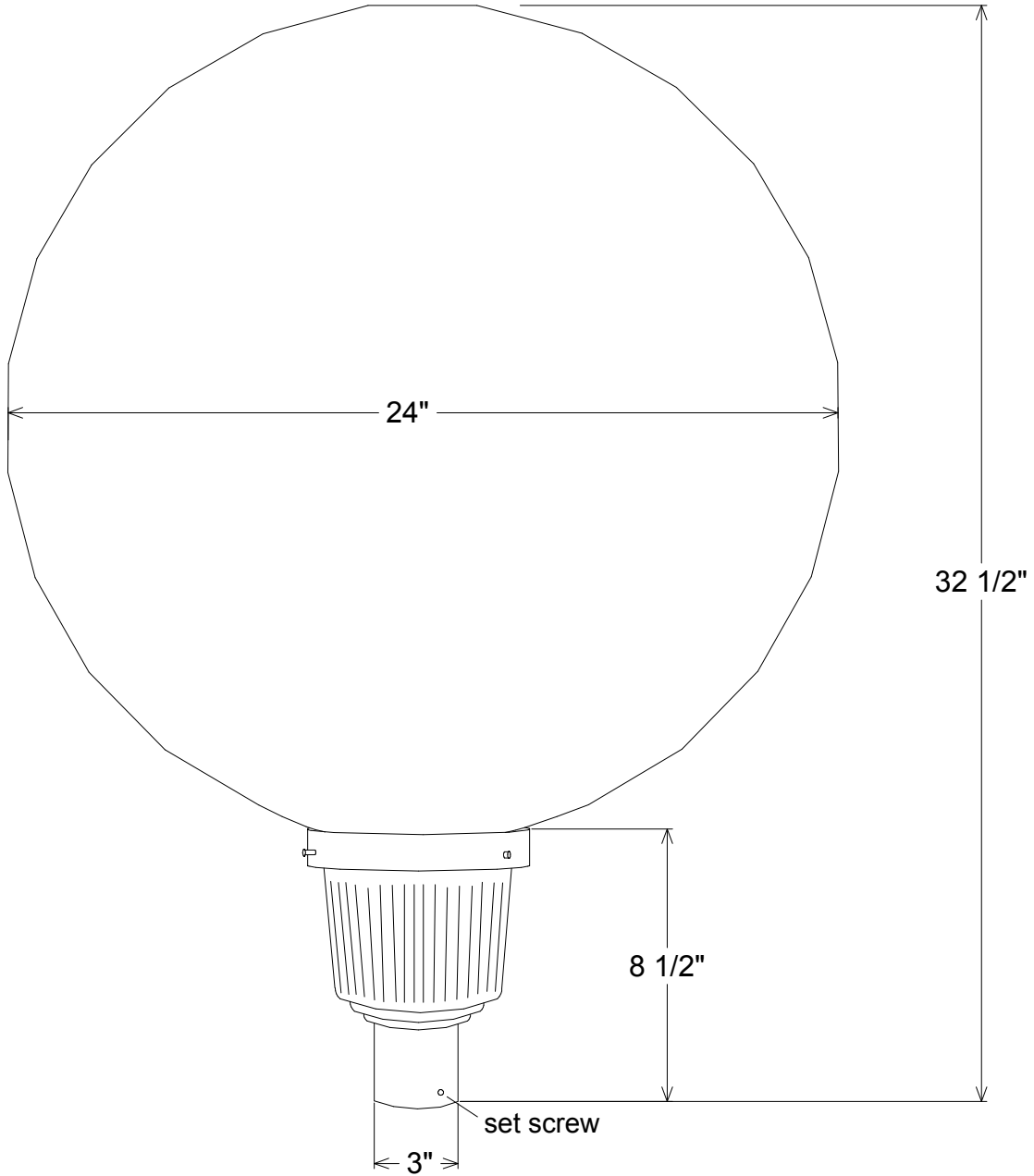

<b>Unless Otherwise Specified:</b> Dimensions in Inches Tolerances: Fractional ± Angular: Mach ± Bend ± Two Place Decimal ± Three Place Decimal ±	Name	Date	<b>Primelite Mfg. Corp.</b>  <b>1794B</b>  <b>24" Superlex Post Light with Ballast Pot</b>		
	Drawn	T.A.R.			09/26/10
	Checked				
	ENG Appr.				
	MFR Appr.				
Construction: All Aluminum	Comments		Size	Drawing No.	Rev
Lamp: 1-500A	CAD Generated Drawing Do Not Manually Update		A	0001	A
			Scale	CAD File	Sheet
			1:5		1 of 1