



Primelite Manufacturing Corp

407 S Main St, Freeport, NY 11520

Phone: 516-868-4411 | Fax: 516-868-4609
 sales@primelite-mfg.com | www.primelite-mfg.com

PART # #1327 LED 68	LAMP Built-In LED	VOLTAGE 120 V	COLOR Powder Coated Paint
JOB NAME			TYPE Post Light

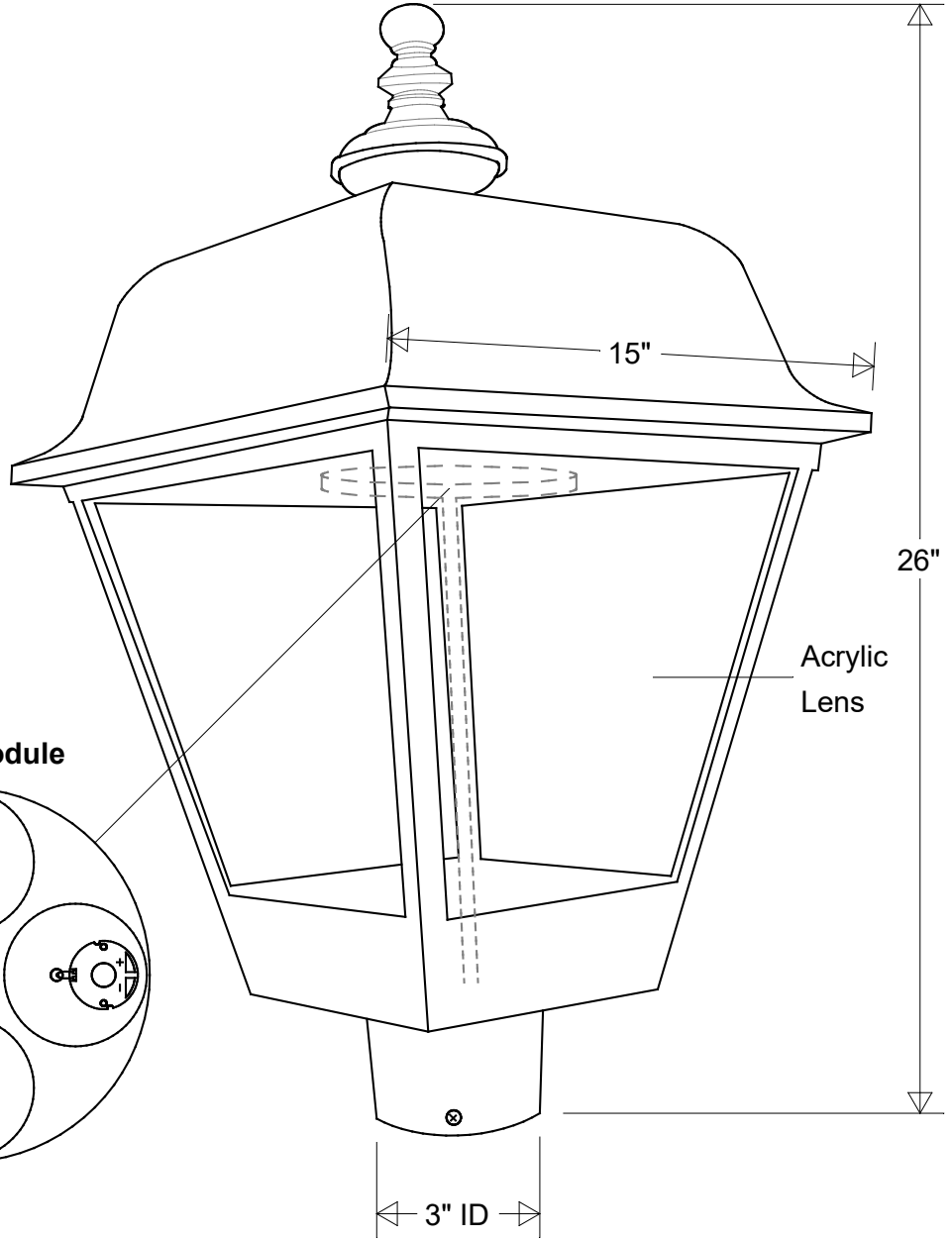

LED 68 Module

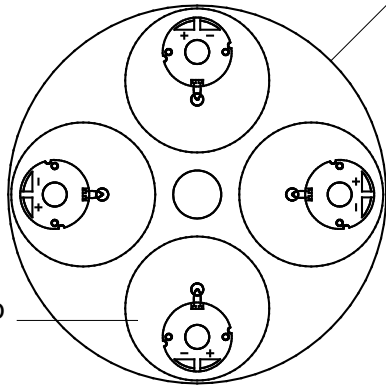

LED 17 Chip
& Heat Sink

Lamp: LED 68 (LED 17 Chip X 4)

175 W MH Equivalent
 3K = 7712 Lumens
 4K = 8552 Lumens



	Initials	Date
Drawn	CB	04/2022
Checked		
ENG Appr.		
MFR Appr.		
QA		

Post Light #1327 LED 68

15" W | 26" H | Fits 3" OD Round Posts

Lens: Smoke (-1) | White (-3) | Clear (-4) | Frost (-5)

Size	Drawing No.	Rev
A	0001	A

Revisions				
Zone	Rev	Description	Date	Appr

Construction:
 Aluminum | Acrylic

Unless Otherwise Specified:
 Dimensions in Inches

Weight:

Scale

CAD File

Sheet

1 of 1