



Primelite Manufacturing Corp.

407 S Main St, Freeport, NY 11520
 Phone: (516) 868-4411 | Fax: (516) 868-4609
 sales@primelite-mfg.com | www.primelite-mfg.com

PROUDLY MADE IN THE USA SINCE 1962!
"SPECIALTIES ARE OUR SPECIALTY!"

Job Info

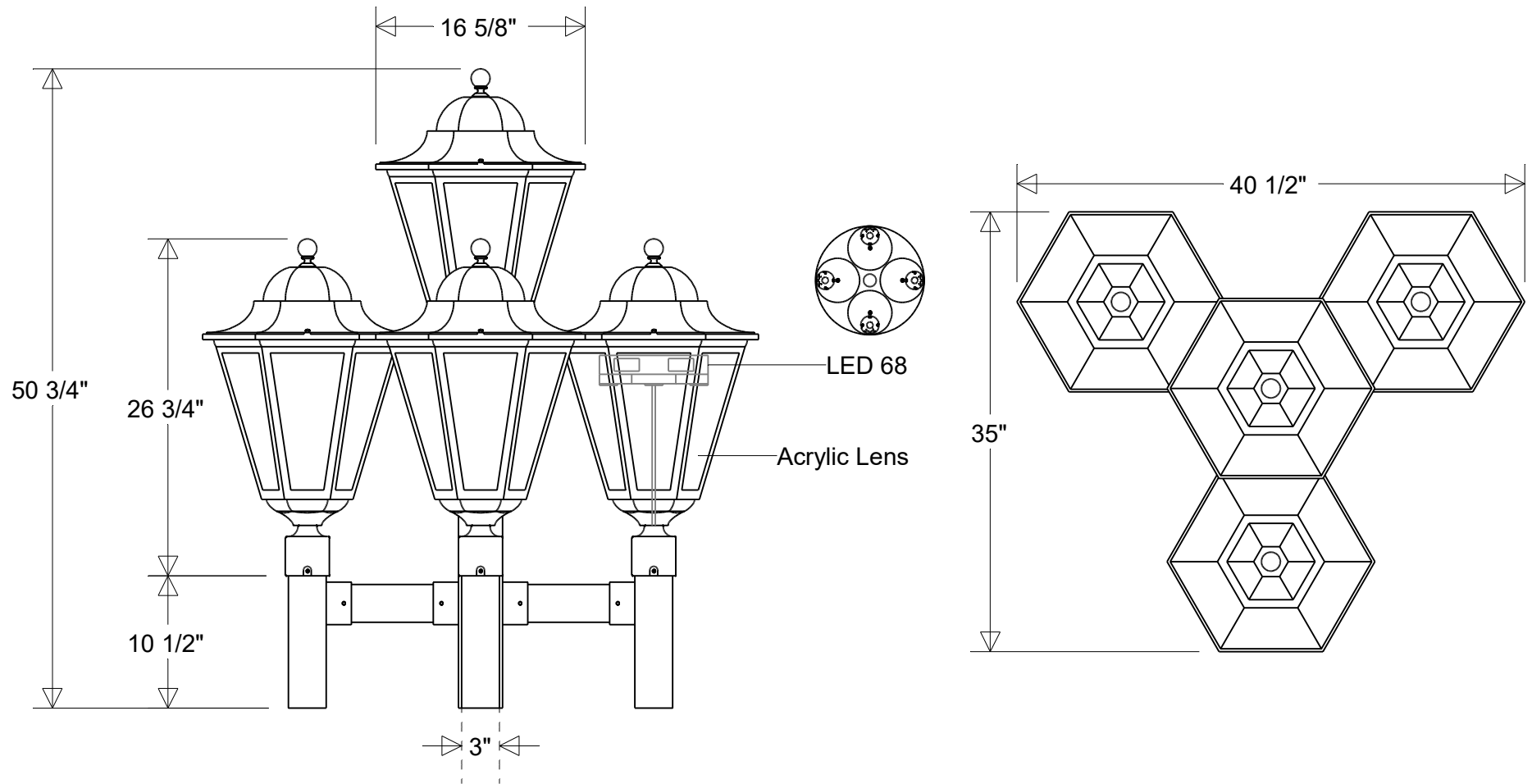

#1325/* H4A LED 68 Dimm

40 1/2" W | 35" Ext | 50 3/4" H | 3" Post Fitter

Lens: Smoke (*1) | White (*3) | Clear (*4) | Frost (*5)

Lamp: 68 W LED x4
 CCT: 3K or 4K | Others
 125W MH Equivalent

80 CRI
 120-277 V
 0-10 V Dimming

Finish:
 29 Oven Baked
 Powder Coated Paints

Material:
 Aluminum
 Acrylic Lens

Drawn:
 CB
 03/2026

Note:
 All dimensions are nominal.
 Actual dimensions may vary.

Scale:
 1 / 12.5

Approvals
