



Primelite Manufacturing Corp.

407 S Main St, Freeport, NY 11520
 Phone: (516) 868-4411 | Fax: (516) 868-4609
 sales@primelite-mfg.com | www.primelite-mfg.com

PROUDLY MADE IN THE USA SINCE 1962!
"SPECIALTIES ARE OUR SPECIALTY!"

Job Info

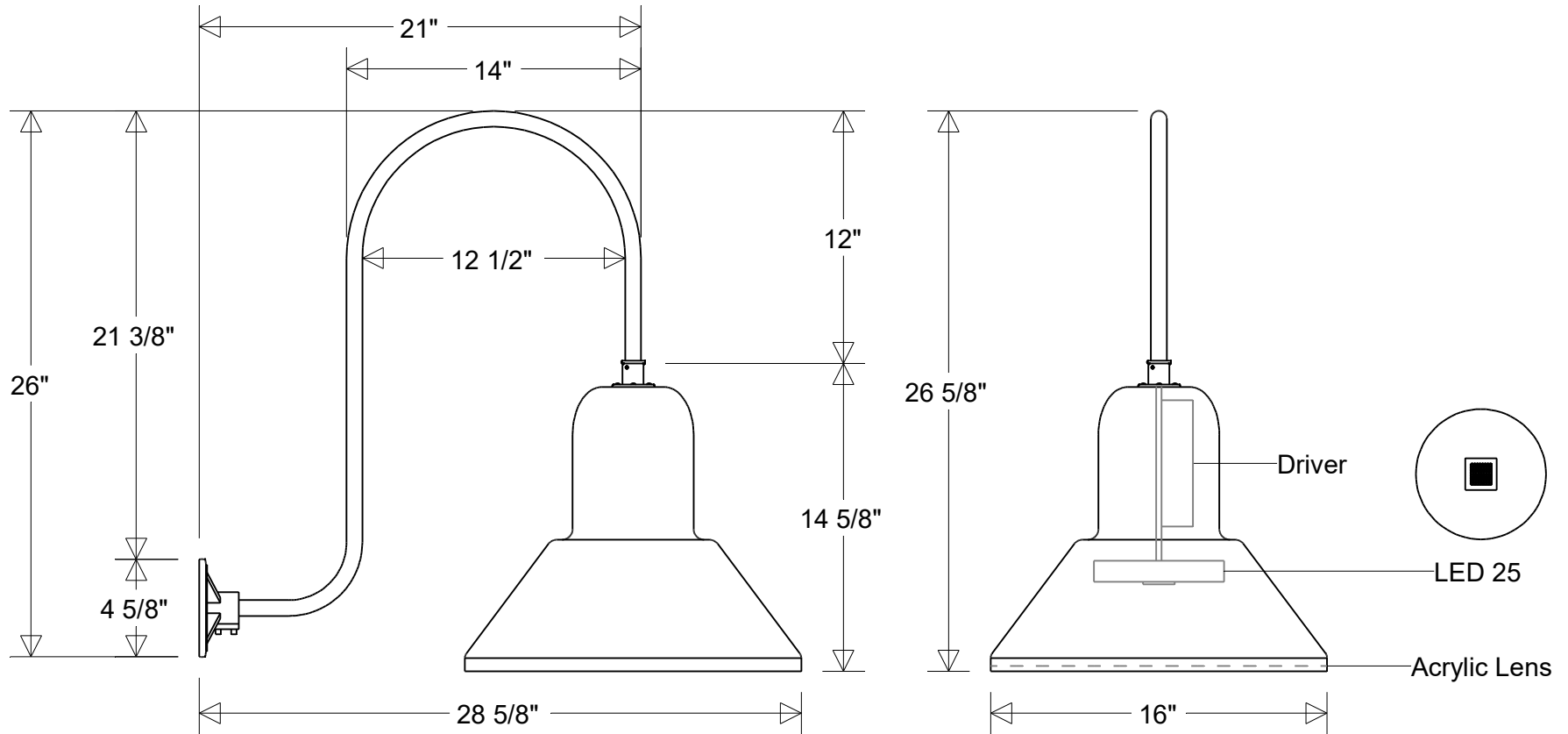

#37/16-874 LED 25 NonDimm

16" Dia | 28 5/8" Ext | 26 5/8" H

Shade: #37/16A LED 25 NonDimm | Arm: #874

Lamp: 25 W LED
 CCT: 3K or 4K | Others
 50W MH Equivalent

80 CRI
 120-277 V
 Non-Dimming

Finish:
 29 Oven Baked
 Powder Coated Paints

Material:
 Aluminum
 Acrylic Lens

Drawn:
 CB
 04/2026

Note:
 All dimensions are nominal.
 Actual dimensions may vary.

Scale:
 1/8

Approvals
