



# Primelite Manufacturing Corp.

407 S Main St, Freeport, NY 11520  
 Phone: (516) 868-4411 | Fax: (516) 868-4609  
 sales@primelite-mfg.com | www.primelite-mfg.com

**PROUDLY MADE IN THE USA SINCE 1962!**  
**"SPECIALTIES ARE OUR SPECIALTY!"**

Job Info

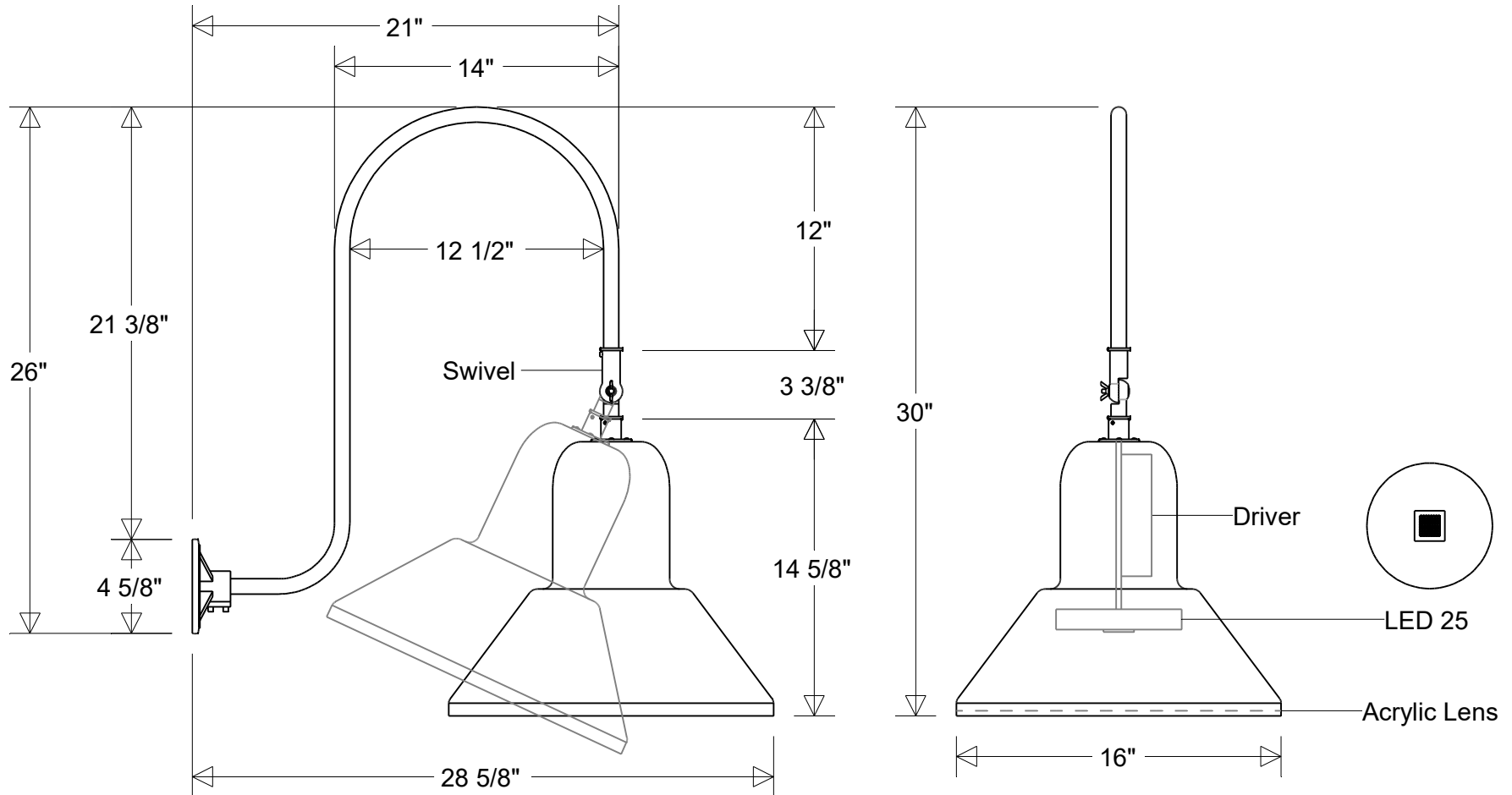

## #37/16-874 ESW LED 25 Dimm

16" Dia | 28 5/8" Ext | 30" H

Shade: #37/16A LED 25 Dimm | Arm: #874 ESW

**Lamp: 25 W LED**  
 CCT: 3K or 4K | Others  
 50W MH Equivalent

80 CRI  
 120-277 V  
 0-10 V Dimming

**Finish:**  
 29 Oven Baked  
 Powder Coated Paints

**Material:**  
 Aluminum  
 Acrylic Lens

**Drawn:**  
 CB  
 04/2026

**Note:**  
 All dimensions are nominal.  
 Actual dimensions may vary.

**Scale:**  
 1/8

Approvals
