



Primelite Manufacturing Corp.

407 S Main St, Freeport, NY 11520
 Phone: (516) 868-4411 | Fax: (516) 868-4609
 sales@primelite-mfg.com | www.primelite-mfg.com

PROUDLY MADE IN THE USA SINCE 1962!
"SPECIALTIES ARE OUR SPECIALTY!"

Job Info

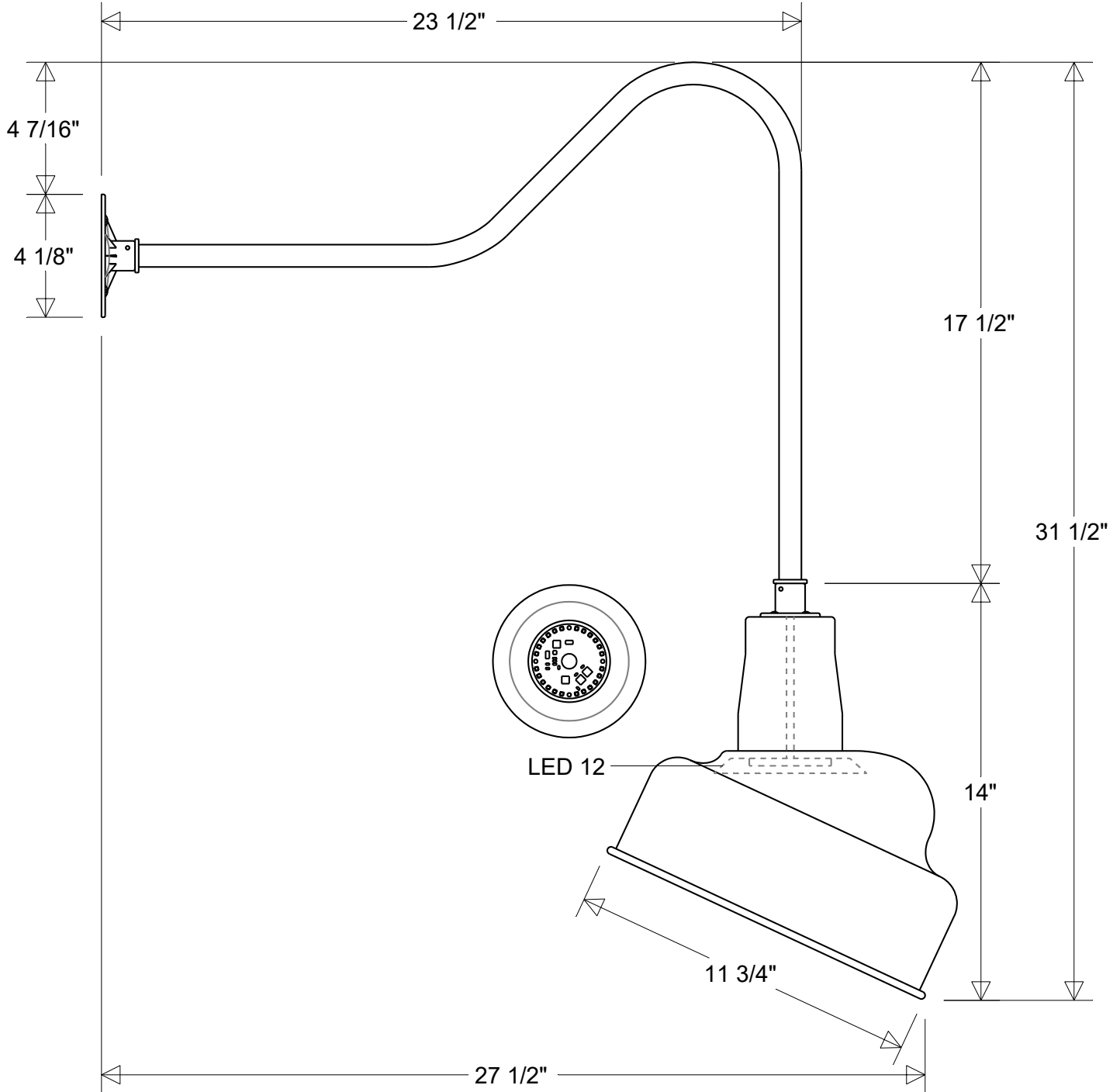

#19/860 LED 12

11 3/4" Dia | 27 1/2" Ext | 31 1/2" H
 Shade: #19A | Arm: #860

Lamp: 12 W LED
 3K: 1140 Lumens
 4K: 1280 Lumens

Voltage:
 120 V

Finish:
 29 Oven Baked
 Powder Coated Paints

Material:
 Aluminum

Drawn:
 CB
 07/2024

Note:
 All dimensions are nominal.
 Actual dimensions may vary.

Scale:
 1/5

Approvals