



Primelite Manufacturing Corp.

407 S Main St, Freeport, NY 11520
 Phone: (516) 868-4411 | Fax: (516) 868-4609
 sales@primelite-mfg.com | www.primelite-mfg.com

PROUDLY MADE IN THE USA SINCE 1962!
"SPECIALTIES ARE OUR SPECIALTY!"

Job Info

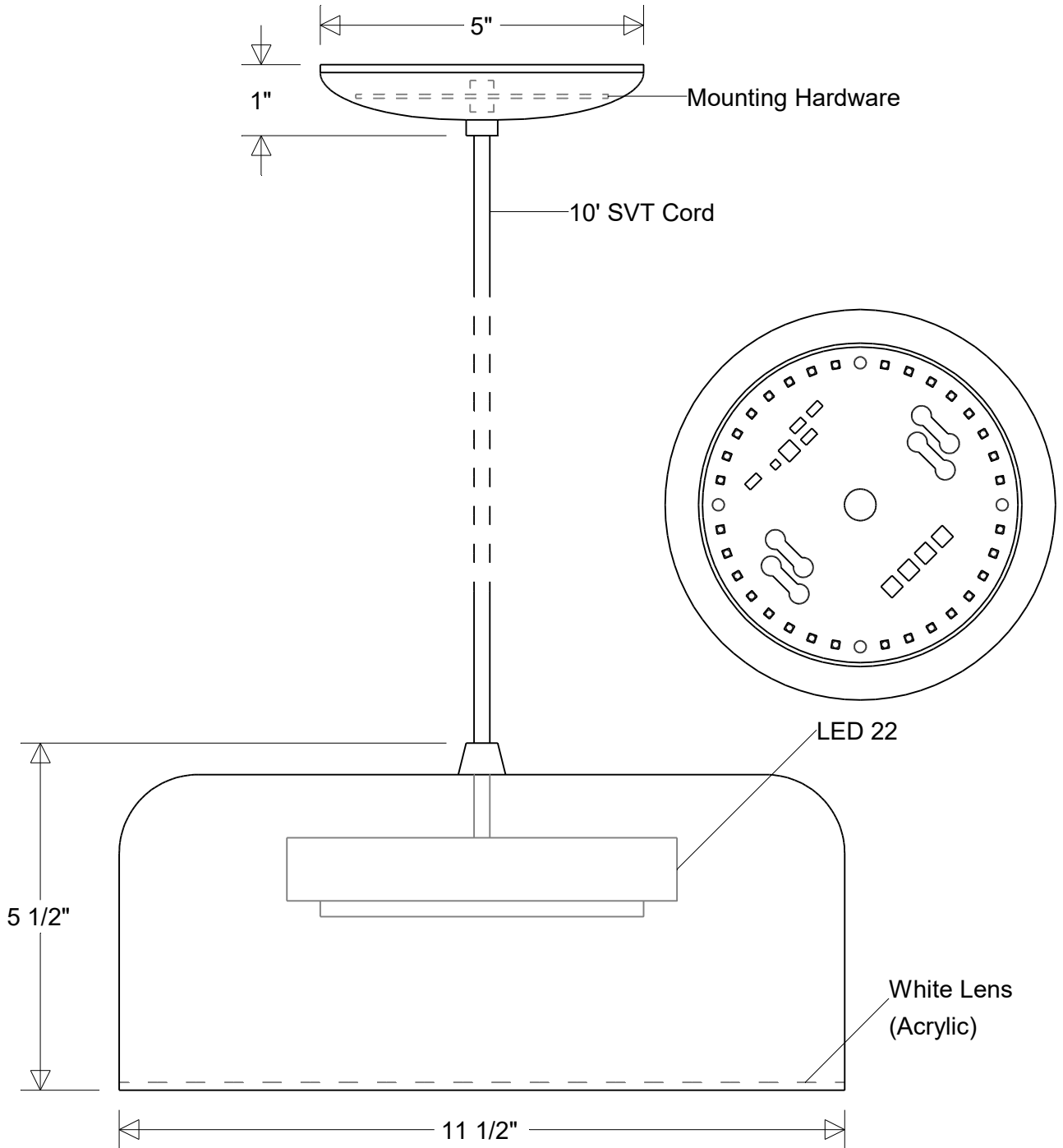

#11038/12 LED 22

11 1/2" Dia | 5 1/2" H
 10' SVT Cord: Black / White

Lamp: 22 W LED
 CCT: 3K or 4K
 125W Inc Equivalent
 80 CRI
 120V
 Electronic Dimming

Finish:
 29 Oven Baked
 Powder Coated Paints
Material:
 Aluminum
 Acrylic Lens

Drawn:
 CB
 04/2026
Note:
 All dimensions are nominal.
 Actual dimensions may vary.

Scale:
 1 / 2.5

Approvals
