



Primelite Manufacturing Corp.

407 S Main St, Freeport, NY 11520
 Phone: (516) 868-4411 | Fax: (516) 868-4609
 sales@primelite-mfg.com | www.primelite-mfg.com

PROUDLY MADE IN THE USA SINCE 1962!
"SPECIALTIES ARE OUR SPECIALTY!"

Job Info

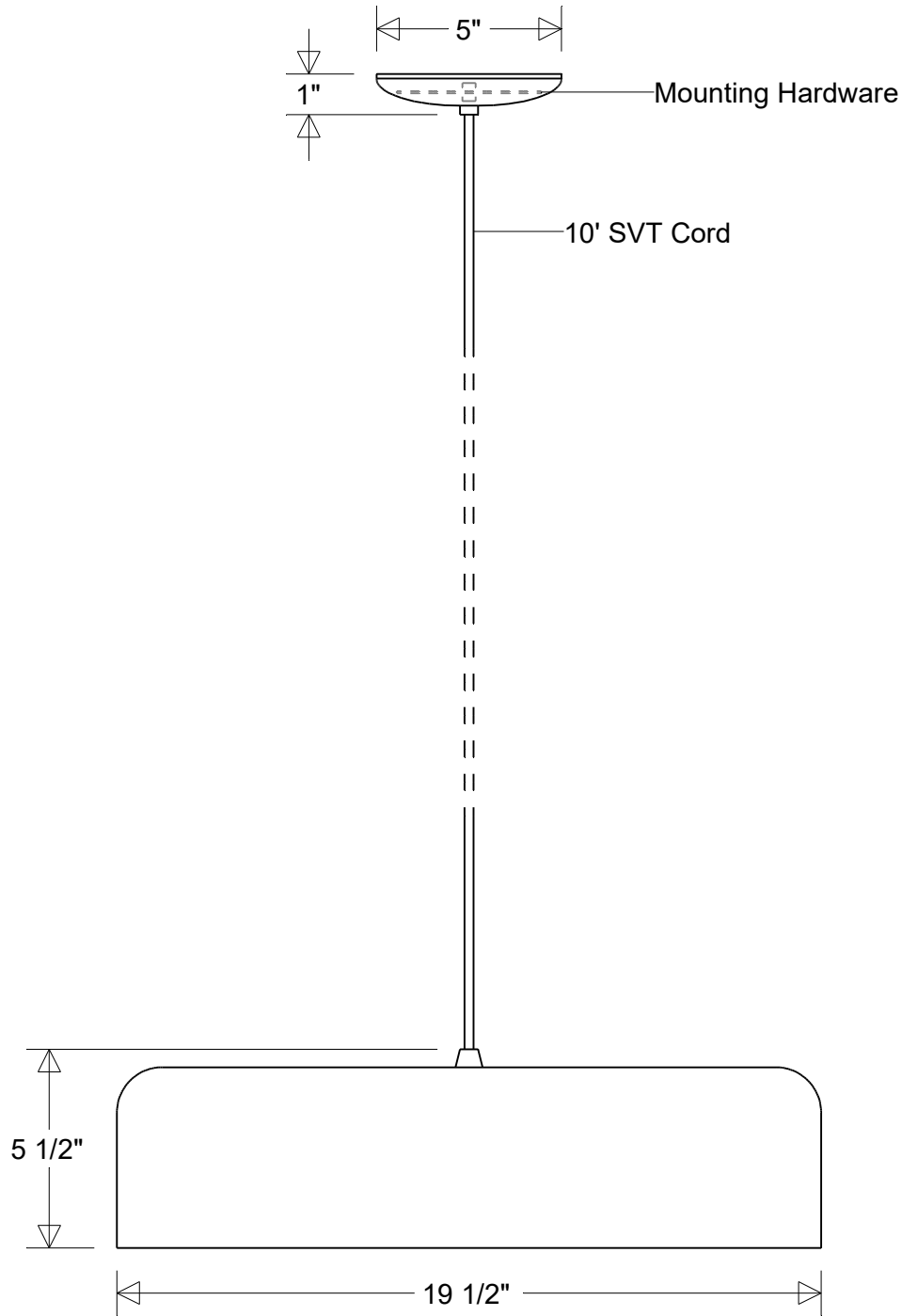

#11037/20 Series

19 1/2" Dia | 5 1/2" H
 10' SVT Cord: Black / White

Lamp Options:

E26 Socket
 LED12 | LED22
 LED48 | LED88

Finish:

29 Oven Baked
 Powder Coated Paints

Material:
 Aluminum

Drawn:

CB
 04/2026

Scale:

1/5

Approvals

Note:
 All dimensions are nominal.
 Actual dimensions may vary.



Primelite Manufacturing Corp.

407 S Main St, Freeport, NY 11520
Phone: (516) 868-4411 | Fax: (516) 868-4609
sales@primelite-mfg.com | www.primelite-mfg.com

PROUDLY MADE IN THE USA SINCE 1962!
"SPECIALTIES ARE OUR SPECIALTY!"

Job Info

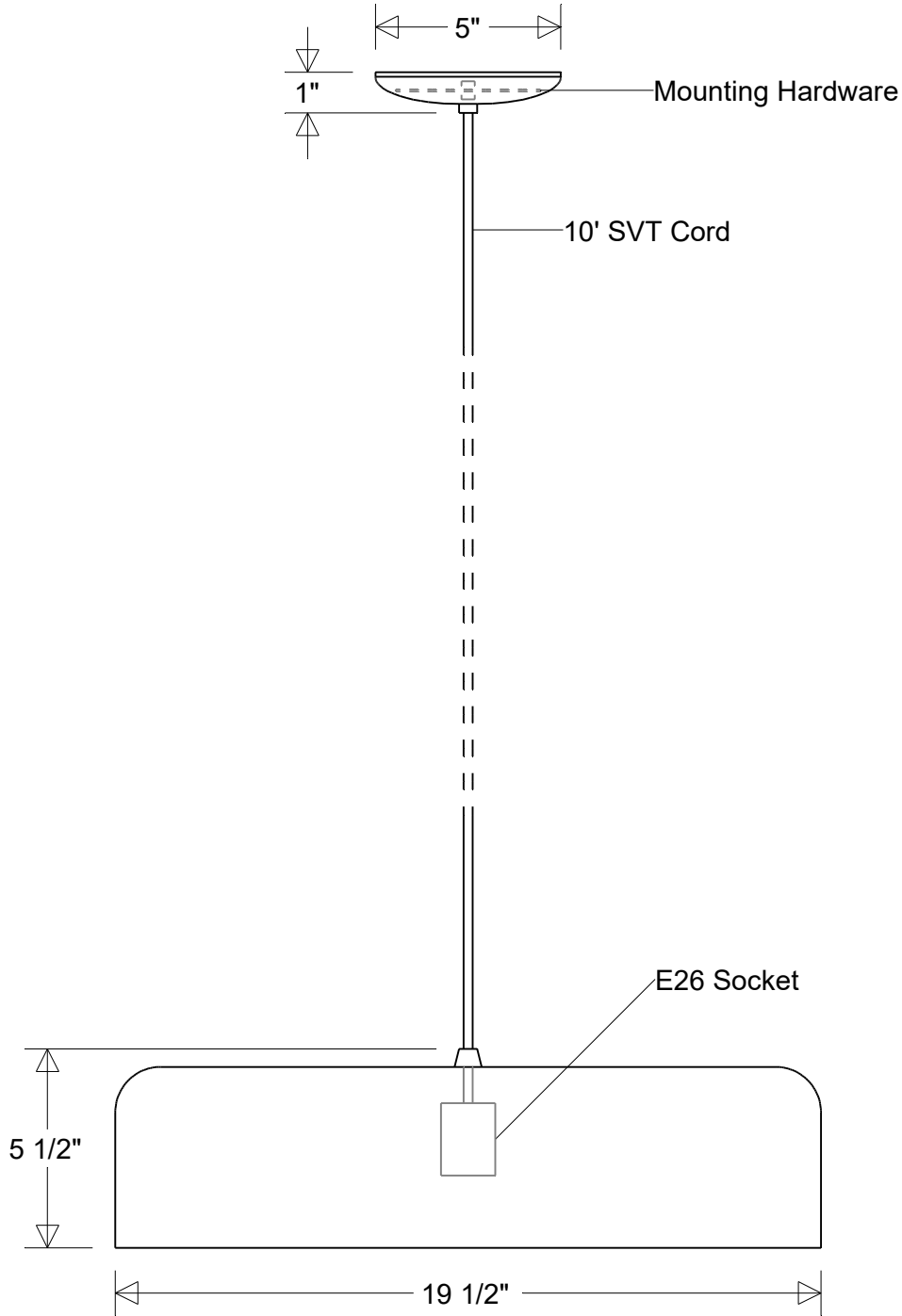

#11037/20

19 1/2" Dia | 5 1/2" H
10' SVT Cord: Black / White

Lamp: E26 Socket

Max Wattage: 60 W

Number of Sockets: 1

120 V

Finish:

29 Oven Baked

Powder Coated Paints

Material:
Aluminum

Drawn:

CB

04/2026

Scale:

1/5

Note:
All dimensions are nominal.
Actual dimensions may vary.

Approvals



Primelite Manufacturing Corp.

407 S Main St, Freeport, NY 11520
 Phone: (516) 868-4411 | Fax: (516) 868-4609
 sales@primelite-mfg.com | www.primelite-mfg.com

PROUDLY MADE IN THE USA SINCE 1962!
"SPECIALTIES ARE OUR SPECIALTY!"

Job Info

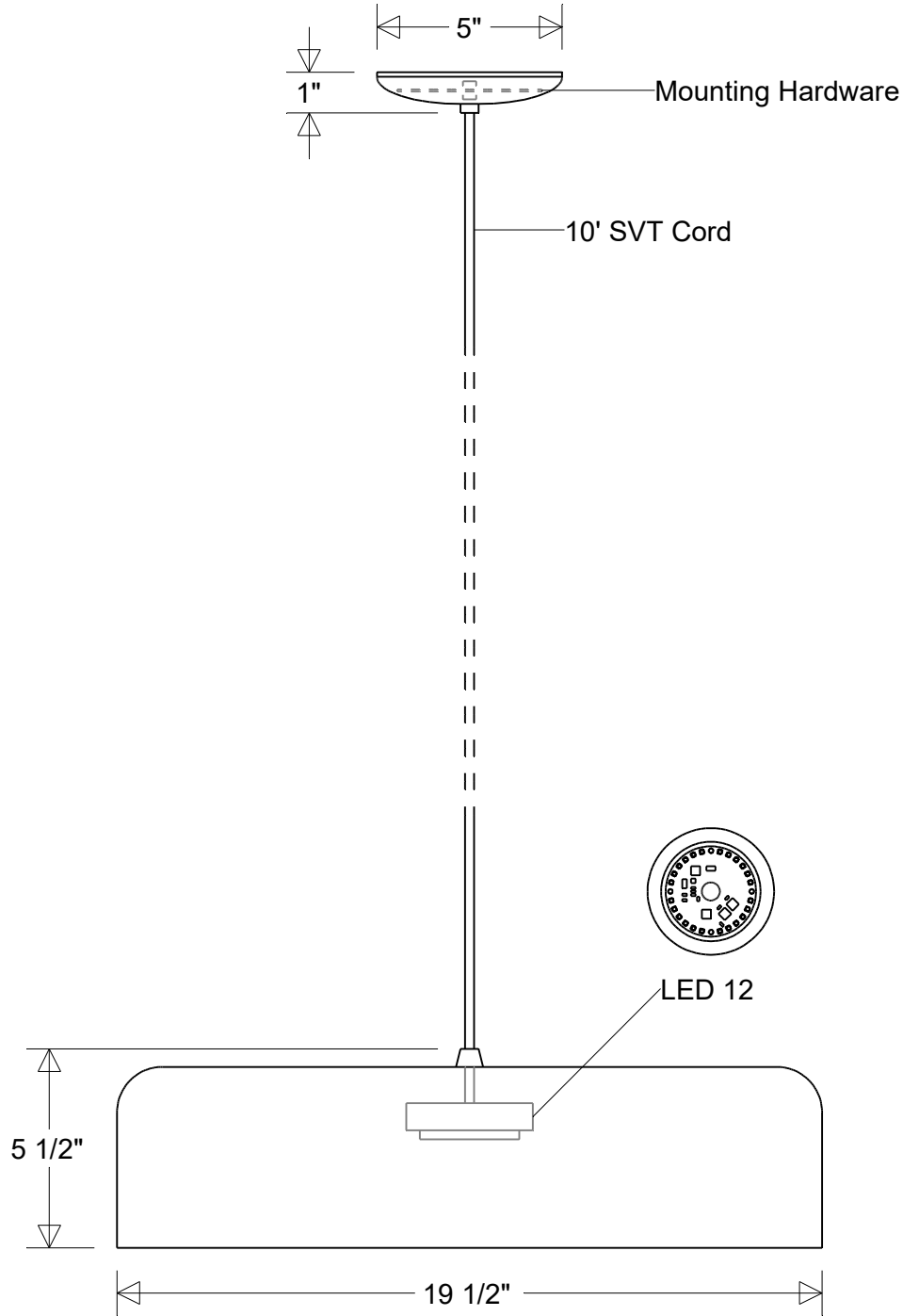

#11037/20 LED 12

19 1/2" Dia | 5 1/2" H
 10' SVT Cord: Black / White

Lamp: 12 W LED
 CCT: 3K or 4K
 75W Inc Equivalent
 80 CRI
 120V
 Electronic Dimming

Finish:
 29 Oven Baked
 Powder Coated Paints
Material:
 Aluminum

Drawn:
 CB
 04/2026

Scale:
 1/5

Note:
 All dimensions are nominal.
 Actual dimensions may vary.

Approvals



Primelite Manufacturing Corp.

407 S Main St, Freeport, NY 11520
 Phone: (516) 868-4411 | Fax: (516) 868-4609
 sales@primelite-mfg.com | www.primelite-mfg.com

PROUDLY MADE IN THE USA SINCE 1962!
"SPECIALTIES ARE OUR SPECIALTY!"

Job Info

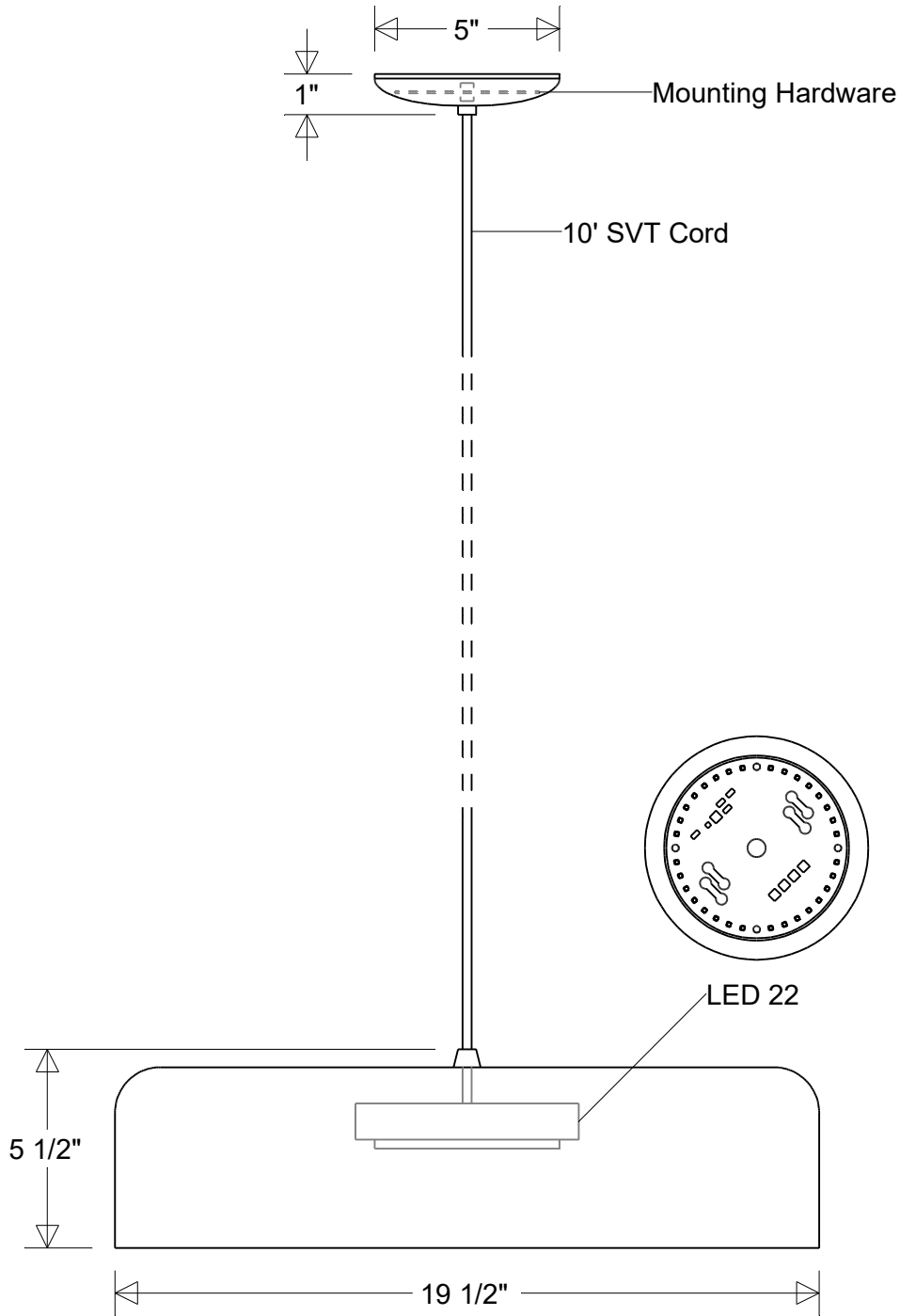

#11037/20 LED 22

19 1/2" Dia | 5 1/2" H
 10' SVT Cord: Black / White

Lamp: 22 W LED
 CCT: 3K or 4K
 125W Inc Equivalent
 80 CRI
 120V
 Electronic Dimming

Finish:
 29 Oven Baked
 Powder Coated Paints
Material:
 Aluminum

Drawn:
 CB
 04/2026

Scale:
 1/5

Note:
 All dimensions are nominal.
 Actual dimensions may vary.

Approvals



Primelite Manufacturing Corp.

407 S Main St, Freeport, NY 11520
 Phone: (516) 868-4411 | Fax: (516) 868-4609
 sales@primelite-mfg.com | www.primelite-mfg.com

PROUDLY MADE IN THE USA SINCE 1962!
"SPECIALTIES ARE OUR SPECIALTY!"

Job Info

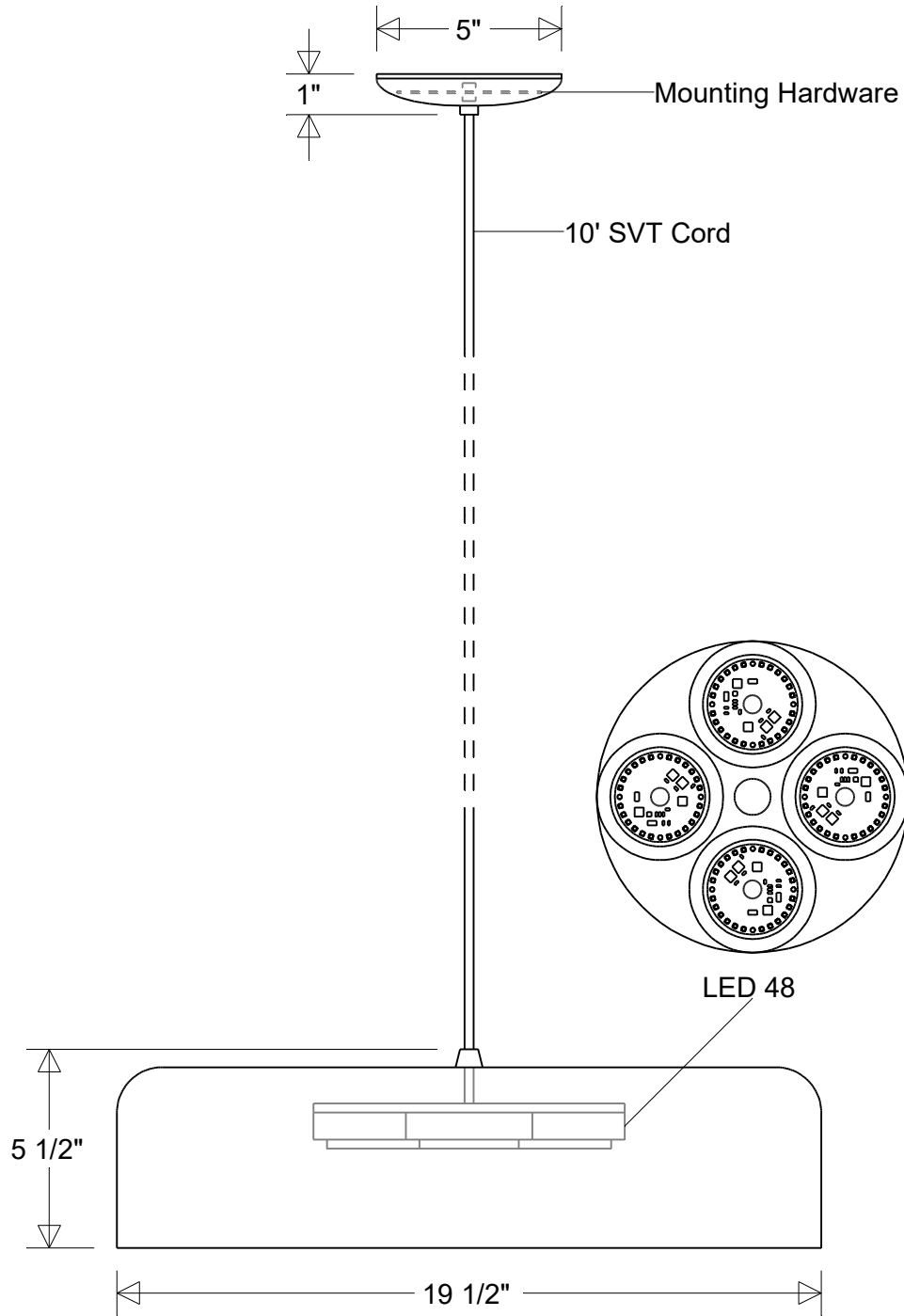

#11037/20 LED 48

19 1/2" Dia | 5 1/2" H
 10' SVT Cord: Black / White

Lamp: 48 W LED
 CCT: 3K or 4K
 75W MH Equivalent
 80 CRI
 120V
 Electronic Dimming

Finish:
 29 Oven Baked
 Powder Coated Paints
Material:
 Aluminum

Drawn:
 CB
 04/2026

Scale:
 1/5

Note:
 All dimensions are nominal.
 Actual dimensions may vary.

Approvals



Primelite Manufacturing Corp.

407 S Main St, Freeport, NY 11520
 Phone: (516) 868-4411 | Fax: (516) 868-4609
 sales@primelite-mfg.com | www.primelite-mfg.com

PROUDLY MADE IN THE USA SINCE 1962!
"SPECIALTIES ARE OUR SPECIALTY!"

Job Info

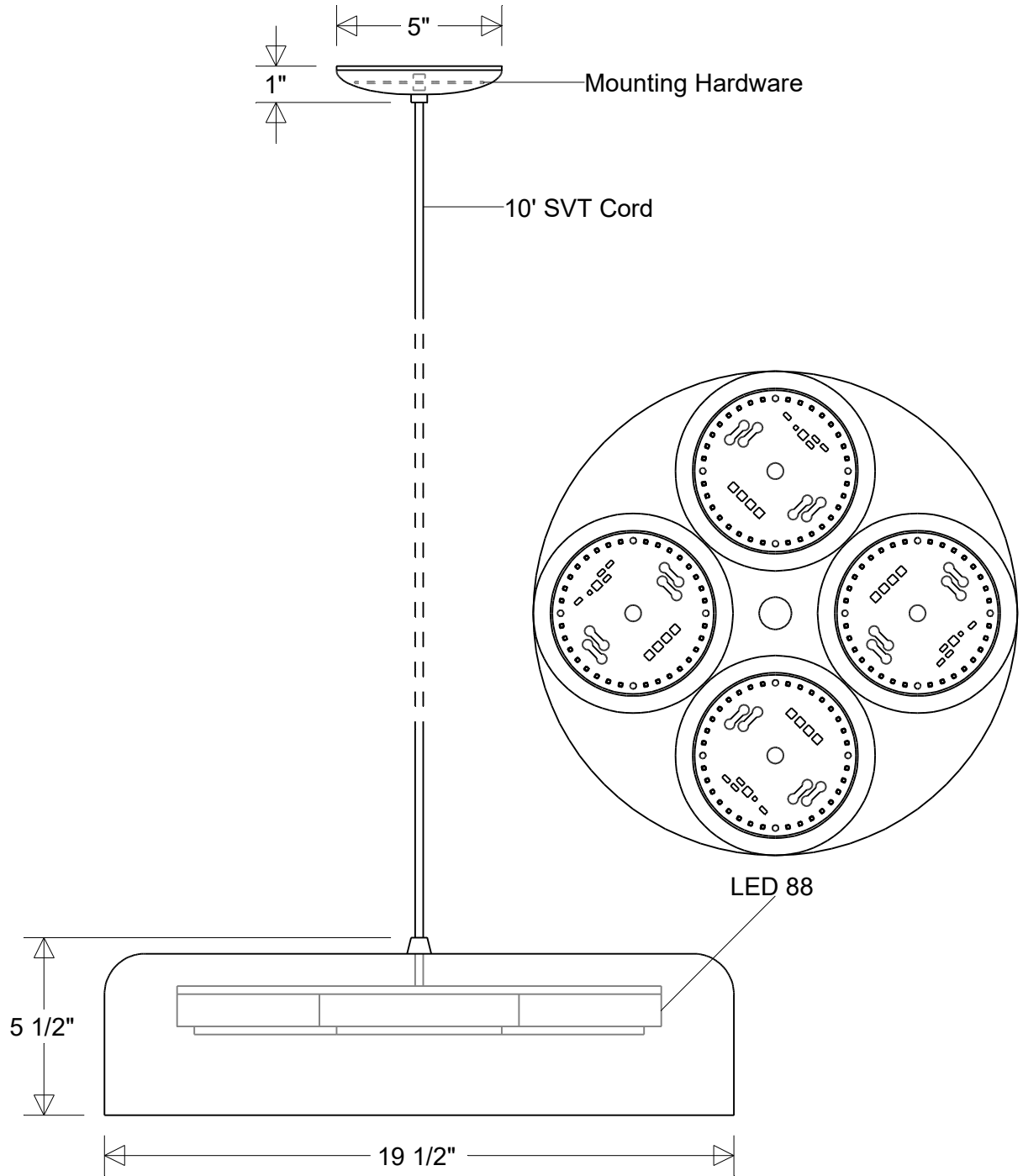

#11037/20 LED 88

19 1/2" Dia | 5 1/2" H
 10' SVT Cord: Black / White

Lamp: 88 W LED
 CCT: 3K or 4K
 100W MH Equivalent
 80 CRI
 120V
 Electronic Dimming

Finish:
 29 Oven Baked
 Powder Coated Paints
Material:
 Aluminum

Drawn:
 CB
 04/2026

Scale:
 1/5

Note:
 All dimensions are nominal.
 Actual dimensions may vary.

Approvals